



CASAMBI



FIXTURE ID 25618

FEATURES

- CONVERTER+CASAMBI+DALI+0/1-10V
- Input: 230Vac
- Command: CASAMBI APP
- Local command: N.O. Push button
- Signal converter from Casambi to DALI
- Signal converter from Casambi to 0/1-10V
- Possibility to control DALI or 0/1-10V devices via the Casambi APP
- Provides power supply to the DALI bus.
- Extended temperature range
- 100% Functional test

PRODUCT DESCRIPTION

SLIM-CBU-DALI is a Casambi to DALI converter or Casambi to 0/1-10V signal. The device receives a command signal from the Casambi APP and converts it into a DALI or 0/1-10V command according to the selected fixture. Send DT6 and DT8 commands or analog commands from 0 to 10V. See the following table "TYPE OF PROFILES" for the reference of the Casambi-DALI conversion addresses.

The CASAMBI APP can be downloaded free of charge from the Apple App Store and the Google Play Store.

→ For the regularly updated manual, consult our website: www.dalcnet.com or QR Code

→ For the correct functioning of the CASAMBI APP, consult the forum on the Casambi website:

<https://support.casambi.com/support/home>



PRODUCT CODE

CODE	POWER SUPPLY	INPUT COMMAND	OUTPUT COMMAND	TYPE OF LOCAL COMMAND
SLIM-CBU-DALI	230Vac	APP CASAMBI	DALI (DT6-DT8) ¹	N° 1 N.O. Push Button

Address management (DALI variant) depends on the configuration of the Casambi module

PROTECTIONS

OVP	Over voltage protection	✓
IFP	Input fuse protection	✓

¹ Address management depends on the configuration of the Casambi module.

TYPE OF PROFILE

PROFILE NAME	# PROFILE	DESCRIPTION
DALI2 BROADCAST* 	25618 (Default)	Dimmer broadcast DALI. DALI dimming curve: logarithmic. Set the power-on level to the maximum level (100% - 254). No addressing is required.
0/1-10V 1CH	29126	One channel dimmer: - Analog output for controlling devices 0/1-10V
W AUTOMATIC	30407	One channel dimmer: - Dimmer 1: address A0 DALI dimming curve: logarithmic. Set the power-on level to the maximum level (100% - 254). The address is automatically assigned to the device if needed
WWW AUTOMATIC	30408	Four channels dimmer: - Dimmer 1: address A0 - Dimmer 2: address A1 - Dimmer 3: address A2 - Dimmer 4: address A3 DALI dimming curve: logarithmic. Set the power-on level to the maximum level (100% - 254). The address is automatically assigned to the device if needed.
TW AUTOMATIC 2700-6000K	30409	Two channels dimmer: - Dimmer 1: address A0 – Warm White - Dimmer 2: address A1 – Cool White DALI dimming curve: linear. Set the power-on level to the maximum level (100% - 254). The address is automatically assigned to the device if needed.
RGB AUTOMATIC	30410	Three channel dimmers. - Dimmer 1: address A0 – Red - Dimmer 2: address A1 – Green - Dimmer 3: address A2 – Blue DALI dimming curve: linear. Set the power-on level to the maximum level (100% - 254). The address is automatically assigned to the device if needed.
RGB+W AUTOMATIC	30411	Four channel dimmers. - Dimmer 1: Red - Dimmer 2: Red - Dimmer 3: Blu - Dimmer 4: White DALI dimming curve: linear. Set the power-on level to the maximum level (100% - 254). The address is automatically assigned to the device if needed.
RGB+TW AUTOMATIC	30412	Five-channel dimmer. - Dimmer 1: Red - Dimmer 2: Green - Dimmer 3: Blu - Dimmer 4: Warm white - Dimmer 5: Cold white DALI dimming curve: linear. Set the power-on level to the maximum level (100% - 254). The address is automatically assigned to the device if needed.

*The Device is certified as DALI2 only with the profile: **25618** – DALI2 BROADCAST

PROFILE NAME	# PROFILE	DESCRIPTION
WWWW GROUP	30416	<p>Four DALI groups, dimmer function.</p> <ul style="list-style-type: none"> - Dimmer 1: group G0 - Dimmer 2: group G1 - Dimmer 3: group G2 - Dimmer 4: group G3 <p>DALI dimming curve: logarithmic. Set the power-on level to the maximum level (100% - 254). The address must be assigned to the device using a DALI Master device.</p>
TW GROUP	30417	<p>Two DALI groups, dimmer function.</p> <ul style="list-style-type: none"> - Dimmer 1: group G0 – Warm White - Dimmer 2: group G1 – Cool White <p>DALI dimming curve: linear. Set the power-on level to the maximum level (100% - 254). The address must be assigned to the device using a DALI Master device.</p>
RGB GROUP	30418	<p>Three DALI groups, dimmer function.</p> <ul style="list-style-type: none"> - Dimmer 1: group G0 – Red - Dimmer 2: group G1 – Green - Dimmer 3: group G2 – Blue <p>DALI dimming curve: linear. Set the power-on level to the maximum level (100% - 254). The address must be assigned to the device using a DALI Master device.</p>
RGB+W GROUP	30419	<p>Four DALI groups, dimmer function</p> <ul style="list-style-type: none"> - Dimmer 1: group G0 – Red - Dimmer 2: group G1 – Green - Dimmer 3: group G2 – Blue - Dimmer 4: group G3 – White <p>Set the power-on level to the maximum level (100% - 254). The address must be assigned to the device using a DALI Master device</p>
RGB+TW GROUP	30420	<p>Four DALI groups, dimmer function</p> <ul style="list-style-type: none"> - Dimmer 1: group G0 – Red - Dimmer 2: group G1 – Green - Dimmer 3: group G2 – Blue - Dimmer 4: group G3 – Warm white - Dimmer 4: group G3 – Cold white <p>DALI dimming curve: linear. Set the power-on level to the maximum level (100% - 254). The address must be assigned to the device using a DALI Master device</p>
8xW GROUP	30421	<p>Eight DALI groups, dimmer function.</p> <ul style="list-style-type: none"> - Dimmer 1: group G0 - Dimmer 2: group G1 - Dimmer 3: group G2 - Dimmer 4: group G3 - Dimmer 5: group G4 - Dimmer 6: group G5 - Dimmer 7: group G6 - Dimmer 8: group G7 <p>DALI dimming curve: logarithmic. Set the Power on Level to the maximum level (100% - 254). The address must be assigned to the device using a DALI Master device</p>

PROFILE NAME	# PROFILE	DESCRIPTION
DALI DT8 CB TW	30425	1 Address to control 2 TW channels. Send DALI DT8 BROADCAST commands for devices that support the "Colour Temperature Tc" function: Dim Level and Color Temperature. DALI dimming curve: linear. Set the power-on level to the maximum level (100% - 254). No addressing is required.
DALI DT8 CB RGB	30426	1 address to control 3 RGB channels. Send DALI DT8 BROADCAST commands for devices that support the "RGBWAF colour-type" function: Dim and RGBWAF. DALI dimming curve: linear. Set the power-on level to the maximum level (100% - 254). No addressing is required.
DALI DT8 CB RGB+W	30427	1 address to control 3 RGB channels. Send DALI DT8 BROADCAST commands for devices that support the "RGBWAF colour-type" function: Dim and RGBWAF. DALI dimming curve: linear. Set the power-on level to the maximum level (100% - 254). No addressing is required.
DALI BC DT8 DIM TO WARM	30428	1 Address to control 2 TW channels. DALI dimming curve: linear. Set the power-on level to the maximum level (100% - 254). No addressing is required.
DALI BC DT8 XY	30429	DALI DT8 multi-channel dimmer supporting 'XY' color type control
DALI BC DT8 XY-TW	30430	DALI DT8 multi-channel dimmer supporting 'XY-TW' color type control

REFERENCE STANDARDS

IN 55015	Limits and methods of measurement of radio disturbance characteristics of electrical lighting and similar equipment
IN 61547	Equipment for general lighting purposes – EMC immunity requirement
IN 61347-1	Lamp Control gear – Part 1: General and safety requirement
IN 61347-2-11	Lamp Control gear – Part 2-11: Particular requirement for miscellaneous electronic circuits used with luminaires

TECHNICAL SPECIFICATIONS

		SLIM-CBU-DALI
Supply voltage²		230 Vac
Voltage range		100 ... 240 Vac
Mains frequency		50/60 Hz
Nominal power @230V²		3 W max
Power loss in standby mode		<500 mW
Operating Frequencies		2402 – 2480 MHz
Maximum output power³		7dBm
Storage temperature³		Min: -40°C Max: +60°C
Ambient temperature, Ta Range²		Min: -25°C Max: +60°C
Type of connector		Push-In terminals
Wiring	Solid size	0,2 ÷ 1,5 mm ² / 24 ÷ 16 AWG
	Stranded size	
Wire strip length		9 ÷ 10 mm
Protection class		IP20
Casing material		Plastic
Packaging units (pieces/units)		1pcs
Mechanical dimensions		136 x 29 x 21 mm
Packaging dimensions		147 x 34 x 29 mm
Weight		62 g

		BUS DALI
I Output (Only for DALI)⁴		Guaranteed current to the bus = 30mA / Max bus current = 250mA
V Output (Only for DALI)⁴		14V

		0/1-10V ANALOG OUTPUT
0-10V – Sink current or Source		10mA
1-10V – Sink current or Source		10mA

² Maximum value, dependent on ventilation conditions.

³ The parameters are derived from the configuration of the Casambi module.

⁴ The SLIM-CBU-DALI has an integrated DALI power supply. Before connecting the SLIM-CBU-DALI to a DALI line, please make sure that no other DALI power Supply is powering the bus.

WIRING DIAGRAM

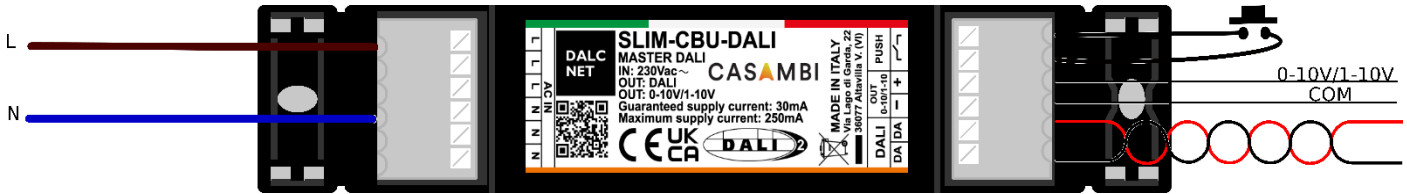

Follow the steps below for product installation as shown in the connection diagram.

- ◆ Installation and maintenance must only be performed by qualified personnel in compliance with current regulations.
- ◆ Installation and maintenance must be performed in the absence of voltage. The power supply must be protected. The product must be protected by a suitably sized circuit breaker.
- ◆ Connect the normally open button to the PUSH terminals with the symbol "  ". Make sure not to connect live parts to the PUSH terminals.
- ◆ Connect the DALI BUS to the "DALI" terminals or connect the 0/1-10V signal to the "OUT 0-10V/1-10V" terminals following the polarity "+" and "-"
- ◆ Connect the power cables to the "AC IN" terminals

Like any other product with Bluetooth control, be sure not to place the product inside a metal case or placed near large metal structures. The metal will significantly obstruct the radio signal, which is crucial for the proper functioning of the device.

LOCAL COMMANDS OPERATION

BUTTON COMMAND NORMALLY OPEN⁵

The Casambi app allows you to program the local command with some prearranged functions.

N° Push Button	Functions		
1	Controls a luminaire	Click Long press (>1s)	Tap to turn a luminaire on or off – hold to adjust luminaire brightness
	Controls an element	Click Long press (>1s)	Tap to turn a device element on or off – hold to adjust the element value
	Control a group	Click Long press (>1s)	Tap to turn a group on or off – hold to adjust brightness
	Control scene	Click Long press (>1s)	Tap to turn a scene on or off – hold to adjust scene brightness
	Control all luminaires	Click Long press (>1s)	Tap to turn all luminaires on or off – hold to adjust brightness
	Cycles scenes	Click Long press (>1s)	Tap to cycle through the list of scenes – hold to adjust current scene brightness
	Active/Standby	Click Long press (>1s)	Tap to switch between two scenes – hold to adjust current scene brightness

For all other functions, please refer to the CASAMBI APP document at:

<https://support.casambi.com/support/home>

UNPAIR DEVICE FROM THE CASAMBI NETWORK

If the device is already connected to a network for which you don't have the credentials and you wish to associate it with a new network, please follow the instructions provided in the Casambi APP's "Nearby Devices" section.

Once the decoupling sequence has started, switch off the main power supply of the Power Supply connected to the SLIM-CBU-DALI and switch it on again within 1 – 2 seconds.

If you do the procedure too quickly, the decoupling may not work properly. Repeat the uncoupling sequence, allowing an extra 1 or 2 seconds to pass between the instant in which the main power supply of the Power Supply is switched off and on again⁶.

A second method to decouple the product is to connect an N.O. to an "INPUT" input of the SLIM-CBU-DALI and during the uncoupling procedure press the button.

⁵ By default, the button is set as "Control a lamp"

⁶ The discharge time of the power supply secondary depends on the construction characteristics of the power supply used.

MECHANICAL DIMENSIONS

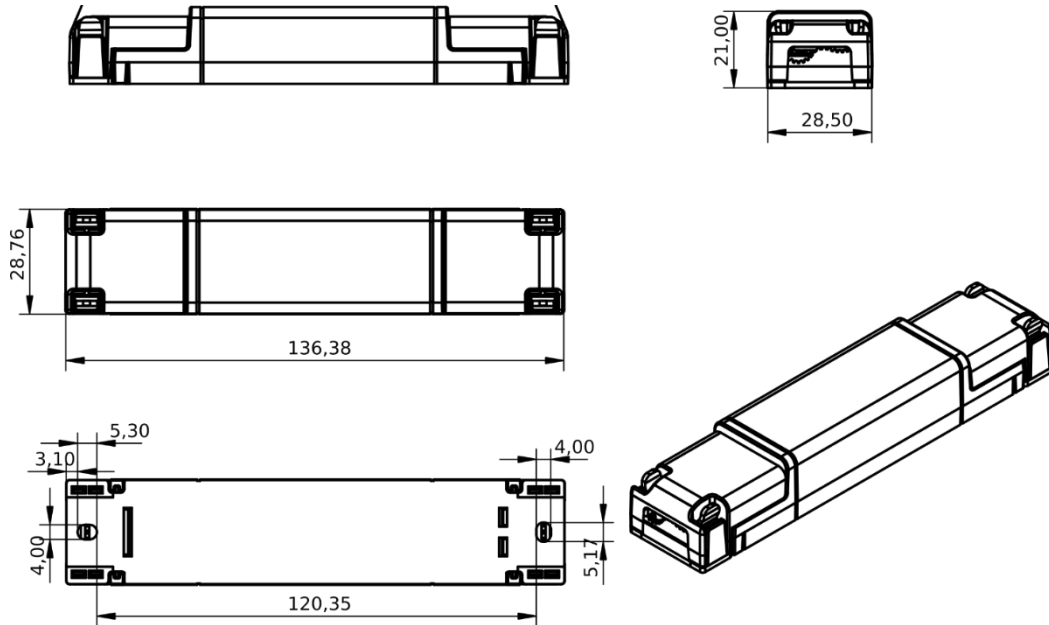

DALI MAP ADDRESSES

"AUTOMATIC" FIXTURE CONFIGURATION:

The "AUTOMATIC" Fixtures automatically direct the UNADDRESSED devices connected to the DALI BUS.



DALI2 BROADCAST

Casambi Slider

Dimmer



Address

BROADCAST

Command

Dimmer ALL



0/1-10V AUTOMATIC

Casambi Slider

Dimmer

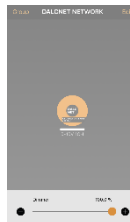

Address

1 Channel

Command

0/1-10V



W AUTOMATIC

Casambi Slider

Dimmer

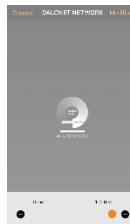

Address

A0

Command

Dimmer 0



WWW AUTOMATIC

Casambi Slider

Dimmer 0

Dimmer 1

Dimmer 2

Dimmer 3

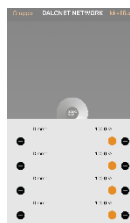

Address

A0

A1

A2

A3

Command

Dimmer 0

Dimmer 1

Dimmer 2

Dimmer 3



TW AUTOMATIC 2700 - 6000K

Casambi Slider

Dimmer

Color temperature



Address

Command

A0

Warm white

A1

Cold white



RGB AUTOMATIC

Casambi Slider

Dimmer

Color

Saturation

Map



Address

Command

A0

R - Red

A1

G - Green

A2

B - Blue



RGB+W AUTOMATIC

Casambi Slider

Dimmer

White / Color

Color

Saturation

Map



Address

Command

A0

R - Red

A1

G - Green

A2

B - Blue

A3

W - White



RGB+TW AUTOMATIC

Casambi Slider

Dimmer

Color temperature

White / Color

Color

Saturation

Map

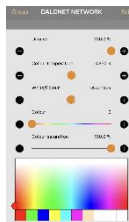

Address

Command

A0

R - Red

A1

G - Green

A2

B - Blue

A3

WW - Warm White

A4

CW - Cool White

FIXTURE "GROUP" CONFIGURATION:

With Fixture "Group" send group commands. To be correctly controlled by these Fixtures, the SLAVE devices must first be addressed and assigned to the desired group via a DALI Master.



WWW GROUP

Casambi Slider

Group 0

Group 1

Group 2

Group 3



Address

Command

G0

Group 0

G1

Group 1

G2

Group 2

G3

Group 3



TW GROUP 2700 - 6000

Casambi Slider

Dimmer

Color temperature



Address

Command

G0

Warm White group

G1

Cool White Group



RGB GROUP

Casambi Slider

Dimmer

Color

Saturation

Map



Address

Command

G0

Red group

G1

Green Group

G2

Blue Group



RGB+W GROUP

Casambi Slider

Dimmer

White / Color

Color

Saturation

Map



Address

Command

G0

Red group

G1

Green Group

G2

Blue Group

G3

White Group



RGB+TW GROUP

Casambi Slider
Dimmer
Color temperature
White / Color
Color
Saturation
Map

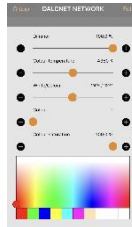

Address	Command
G0	Red group
G1	Green Group
G2	Blue Group
G3	Warm White group
G4	Cool White Group



8W GROUP

Casambi Slider
Group 0
Group 1
Group 2
Group 3
Group 4
Group 5
Group 6
Group 7



Address	Command
G0	Group 0
G1	Group 1
G2	Group 2
G3	Group 3
G4	Group 4
G5	Group 5
G6	Group 6
G7	Group 7

FIXTURE CONFIGURATION "DT8 BC":

The "DT8 BC" fixture send broadcast commands to device compliant with IEC 62386-209 – "Device Type 8".



DALI DT8 BC TW 2700 - 6000K

Casambi Slider

Dimmer

Color temperature



Address

Broadcast

Command

DT8 Dimming + CCT



DALI DT8 BC RGB

Casambi Slider

Dimmer

Color

Saturation

Map

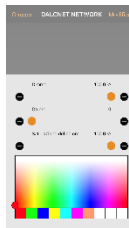

Address

Broadcast

Command

DT8 Dimming + RGB



DALI DT8 BC RGB+W

Casambi Slider

Dimmer

White / Color

Color

Saturation

Map

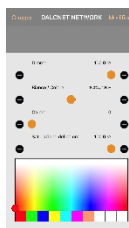

Address

Broadcast

Command

DT8 Dimming + RGBW



DALI DT8 BC RGB+TW

Casambi Slider

Dimmer

Color temperature

White / Color

Color

Saturation

Map

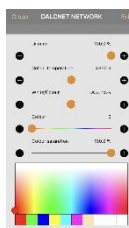

Address

Broadcast

Command

DT8 Dimming + RGBTW



DALI DT8 XY

Casambi Slider

Dimmer

X

Y

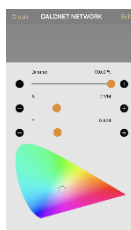

Address

Broadcast

Command

DT8 Dimming XY



DALI DT8 XY+TW

Casambi Slider

Dimmer

Color temperature

X

Y

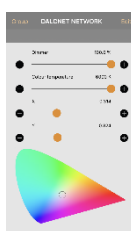

Address

Broadcast

Command

DT8 Dimming XY+TW

TECHNICAL NOTES

INSTALLATION:

- **CAUTION:** The product may only be connected and installed by qualified personnel. All applicable regulations, legislation, and building codes in force in the respective countries must be observed. Incorrect installation of the product can cause irreparable damage to the product and the connected LEDs.
Pay attention when connecting the LEDs: polarity reversal results in no light output and often damages the LEDs.
- Isolate the mains supply before the installation or adjusting the device. Installation and maintenance must be performed in the absence of AC Voltage.
- The product must be installed inside a switchgear/controlgear cabinet and/or junction box protection against overvoltage.
- If required, the product must be protected by a suitably sized fuse.
- The external supply must be protected. The product must be protected by a properly sized Miniature Circuit Breaker (MCB) with overcurrent protection.
- The product must be installed in a vertical or horizontal position with the label/top cover facing upwards or vertically. Other positions are not permitted. The bottom position is not permitted (label/top cover facing down).
- Keep separated 230Vac (LV) circuits and not SELV circuit from safety extra low voltage (SELV) circuit.
- It is absolutely forbidden to connect, for any reason, directly or indirectly, the 230Vac mains voltage to the BUS terminals.
- If required, the product must be dissipated correctly.
- Use the product in harsh environments could limit the output power.
- For built-in components inside luminaires, the ta ambient temperature range is a guideline given for the optimum operating environment. However, integrator must always ensure proper thermal management (i.e. correct mounting of the device, air flow etc.) so that the tc point temperature does not exceed the tc maximum limit in any circumstance. Reliable operation and lifetime are only guaranteed if the maximum tc point temperature is not exceeded under the conditions of use.
- The SLIM-CBU-DALI has an integrated DALI power supply. Before connecting the SLIM-CBU-DALI to a DALI line, please make sure that no other DALI power Supply is powering the bus.

COMMAND and OUTPUT

- The length of the cables connecting between the local commands (0-10V, 1-10V or other) and the product must be less than 25m. The cables must be properly dimensioned and must be insulated from any non-SELV wiring or voltage. It is recommended to use double insulated cables, if deemed appropriate also shielded.
- The length and type of cables connecting to the bus (DALI or other) must comply with the specifications of the respective protocols and the regulations in force. They must be insulated from any wiring or non-SELV voltage parts. It is recommended to use double insulated cables.
- ALL device and control signal connected to the local command "N.O. Push button, potentiometer or other" with symbol  they must not supply any type of voltage.
- ALL device and control signal connect at the BUS (DALI or other) and to the local command (0-10V, 1-10V or other) must be SELV type (the device connected must be SELV or supply SELV signal).
- It is recommended a length of the connecting cables between the product and the LED module less than 25m. The cables must be properly dimensioned. It is recommended to use double insulated cables.



FOR CASAMBI/BLE PRODUCTS:

- **ATTENTION:** in order not to compromise and jeopardize the correct functioning of the device, the device must not be shielded in any way and/or installed inside metal or aluminium boxes or near metal structures. Like any other Casambi product, it should not be placed in a metal container or next to large metal structures. The metal will effectively block all radio signals which are critical to the product's operation.

WARNINGS

- To guarantee the best performance and the most recent functions made available by Casambi, make sure you have installed the latest version of the Casambi APP on your device.
- If the Casambi APP requires it, upgrade the FW version of the installed device. This guarantees the latest features and innovations available.
- To guarantee the best performance and correct functioning to the end user, a functional test is carried out on 100% of the devices. If the device has remained associated with the Dalcnet test network, please uncouple the device by following the information given in the Casambi APP and in the paragraph "[UNPAIRING THE DEVICE FROM THE CASAMBI NETWORK](#)".

SYMBOLOLOGIES

	<p>All products are manufactured in compliance with European Directives, as reported in the EU Conformity Declaration.</p>
	<p>Independent lamp Controlgear: lamp controlgear consisting of one or more separate elements so designed that it can be mounted separately outside a luminaire, with protection according to the marking of the lamp controlgear and without any additional enclosure</p>
	<p>At the end of its useful life the product described in this datasheet is classified as waste from electronic equipment, and cannot be disposed together with the municipal undifferentiated solid waste. Warning! Incorrect disposal of this product may cause serious damage to the environment and human health. Please be informed about the correct disposal procedures for waste collecting and processing provided by local authorities.</p>