



FEATURES

- ◆ LED DIMMER
- ◆ Power input: 12-24-48 Vdc
- ◆ Voltage output for LED strips and LED modules
- ◆ WHITE and MONOCHROME Light Control
- ◆ Device configuration and DALI commissioning using Dalcnet LightApp mobile application
- ◆ BUS Command: DALI
- ◆ MULTI INPUT – Analogic Automatic Detection of the Local Command
 - N°1 Push button normally open
 - 0-10V
 - 1-10V
 - Potentiometer 10KOhm
- ◆ Constant voltage outputs for resistive loads
- ◆ PWM modulation
- ◆ PWM frequency can be set by APP
- ◆ Dimming curve can be set by APP
- ◆ Dimming Fade can be set by APP
- ◆ Soft start and soft stop
- ◆ Extended temperature range
- ◆ 100% Functional Test

PRODUCT DESCRIPTION

The MINI-1CV-DALI is a single-channel LED dimmer, controllable with DALI protocol or with a normally open push-button, a 0-10V/1-10V signal or potentiometer.

The LED dimmer is suitable for driving loads such as LED strips and LED modules, White and single-color constant voltage. It is possible to connect a power supply at 12-24-48 Vdc.

The maximum value of the output current is 10A. The LED dimmer has the following protections: over voltage protection, under-voltage protection, reverse polarity protection, input fuse protection, short circuit protection, short circuit detection and open circuit detection.

Using the Dalcnet LightApp mobile application you can configure multiple parameters of the MINI-1CV-DALI such as Dimming frequency, Dimming curve, max and min brightness level, Fade time etc.

LightApp is free to download from the Apple App Store and Google Play Store.

→ For the always updated manual, consult our website: www.dalcnet.com or QR Code



PRODUCT CODE

CODE	POWER SUPPLY	OUTPUT LED	N° OF CHANNEL	BUS COMMAND	ANALOGIC AUTO DETECTION	APP CONFIG
MINI-1CV-DALI	12-24-48 VDC	1 x 10A ¹	1	DALI	N°1 N.O. Push Button 0-10V 1-10V Potentiometer 10kOhm	LIGHTAPP

PROTECTIONS

OVP	Over-voltage protection ²		✓
UVP	Under-voltage protection ²		✓
RVP	Reverse polarity protection ²		✓
IFP	Protection with input fuse ²		✓
SCP	Short circuit protection		✓
SCD	Short circuit detection		✓
OCD	Open circuit detection		✓

REFERENCE STANDARDS

EN 55015	Limits and methods of measurement of radio disturbance characteristics of electrical lighting and similar equipment
EN 61547	Equipment for general lighting purposes – EMC immunity requirement
EN 61347-1	Lamp Controlgear – Part 1: General and safety requirement
EN 61347-2-13	Lamp Controlgear – Part 2-13: Particular requirement for d.c. or a.c. supplied electronic Controlgear for LED modules
IEC 62386-101 ED2	Digital addressable lighting interface – Part 101: General requirements – System components
IEC 62386-102 ED2	Digital addressable lighting interface – Part 102: General requirements – Control gear
IEC 62386-207 ED2	Digital addressable lighting interface – Part 207: Particular requirements for control gear – LED modules (device type 6)

¹ The maximum output current depends on the operating conditions and the ambient temperature of the installation. For the correct configuration, check the maximum power that can be delivered in the "[Technical Specifications](#)" section and the "[Thermal Characterization](#)".

² Protections refer to the control logic of the board.

TECHNICAL SPECIFICATIONS

		MINI 1CV DALI
Supply voltage		12 / 24 / 48 Vdc
DC voltage range		Min: 10,8 Vdc – Max: 52,8 Vdc
Supply current		Max 10 A
Output voltage		= Vin
Output current³		max 10A @35°C – max 8A @45°C – max 6A @60°C
Nominal power	12 Vdc	120 W
	24 Vdc	240 W
	48 Vdc	480 W
Power loss in standby mode		< 0,5 W
Type of load⁴		R
Dimming curve		Logarithmic – Linear
Dimming method		Pulse Width Modulation "PWM"
PWM frequency⁵		300 – 660 – 1300 – 2000 – 4000 Hz
PWM resolution		16bit
Storage temperature		Min: -40°C – Max: 60°C
Ambient temperature, Ta range³		Min: -10°C – Max: 60°C
Type of connector		Screw terminals
Wiring	Solid Size	0,05 ÷ 2,5 mm ² / 30 ÷ 12 AWG
	Stranded size	
Wire strip length		6,5 mm
IP protection grade		IP20
Casing material		Plastic
Packaging unit (pieces/unit)		1pz
Mechanical dimension		44 x 57 x 25 mm
Packaging dimension		56 x 68 x 35 mm
Weight		47g

³ For the complete range or check the [Thermal Characterization](#) of the product.

⁴ Type of load: Resistive and DC/DC Converter.

⁵ The parameters are derived from the configuration of the LIGHTAPP

WIRING DIAGRAM

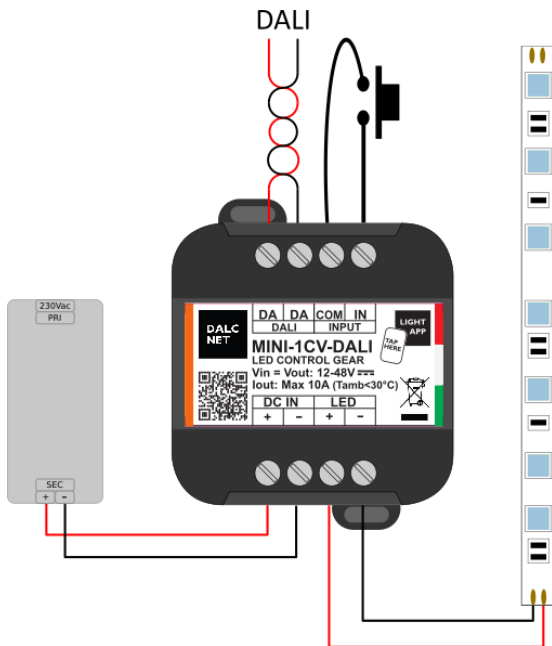

As shown in the connection diagram, perform the following steps to install the product:

- ◆ Connect the LED load to the "LED" terminal respecting the indicated polarity.
- ◆ Local command wiring:
 - Connect the normally open button to the "INPUT" terminals with the "COM" and "IN" symbols.
Be sure not to connect live parts to the "INPUT" terminals.
 - Connect the positive control of the 0/1-10V signal to the "INPUT" terminal with the "IN" symbol, instead the negative of the 0/1-10V signal to the "INPUT" terminal with the "COM" symbol.
 - Connect the 10kOhm potentiometer to the "INPUT" terminals with the symbols "COM" and "IN".
Be sure not to connect live parts to the "INPUT" terminals.
- ◆ Connect the BUS command to the "DALI" terminal.
- ◆ Connect a constant voltage SELV power supply 12-24-48 Vdc (depending on the technical characteristics of the connected LED load) to the DC IN terminal respecting the indicated polarity.
Make sure you are not using a power supply with a constant current output and check that the polarity of the cables is correct.

LOCAL COMMAND FUNCTIONALITY

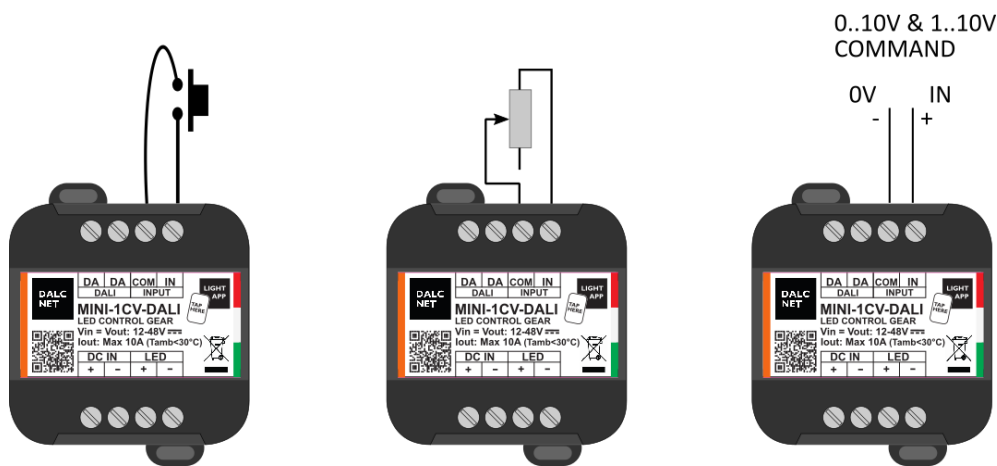

AUTOMATIC DETECTION OF LOCAL COMMAND

At the first power on, by default the device is set to automatically recognize the N.A button.

AUTOMATIC RECOGNITION OF 0-10V / 1-10V / POTENTIOMETER MODE

If a 0-10V/1-10V command or a 10kOhm potentiometer is connected, a quick change in the signal or potentiometer adjustment is sufficient for the device to recognize the new type of command.

During operation in 0-10V / 1-10V / Potentiometer mode, the parameters that can be set via app will be only the dimming curve and the PWM frequency. All other parameters set for push-button operation will be ignored in this mode.

AUTOMATIC BUTTON MODE RECOGNITION

If an N.O. button is connected, 5 quick presses are sufficient for the device to recognize the new type of command.

DALI BUS SETUP

IN DALI SETUP ALL THE LEDs ARE CONTROLLED BY AN EXTERNAL DALI CONTROLLER

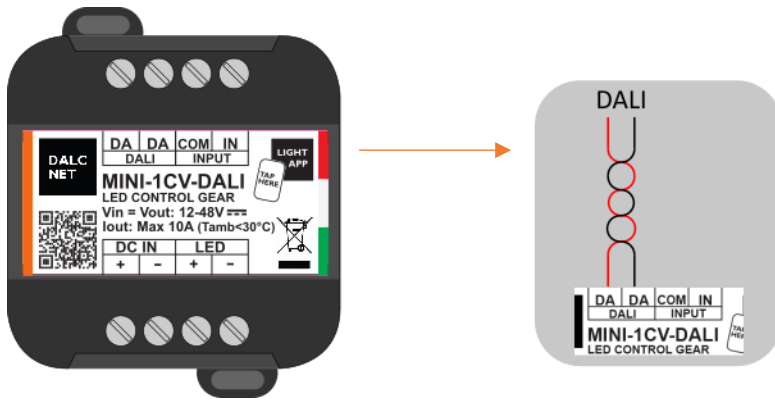

REFERENCE STANDARD

IEC 62386-101 ED2	Digital addressable lighting interface – Part 101: General requirements – System components
IEC 62386-102 ED2	Digital addressable lighting interface – Part 102: General requirements – Control gear
IEC 62386-207 ED2	Digital addressable lighting interface – Part 207: Particular requirements for control gear – LED modules (device type 6)

ADDRESSING

Simplified method – One ballast connected at time	✓
Random Address Allocation	✓

ADDRESSES MAP

The intensity and the status are controlled by DALI controller.

Address	Function	Value
0	Dimmer	Intensity [0...254]

OPERATING WINDOWS

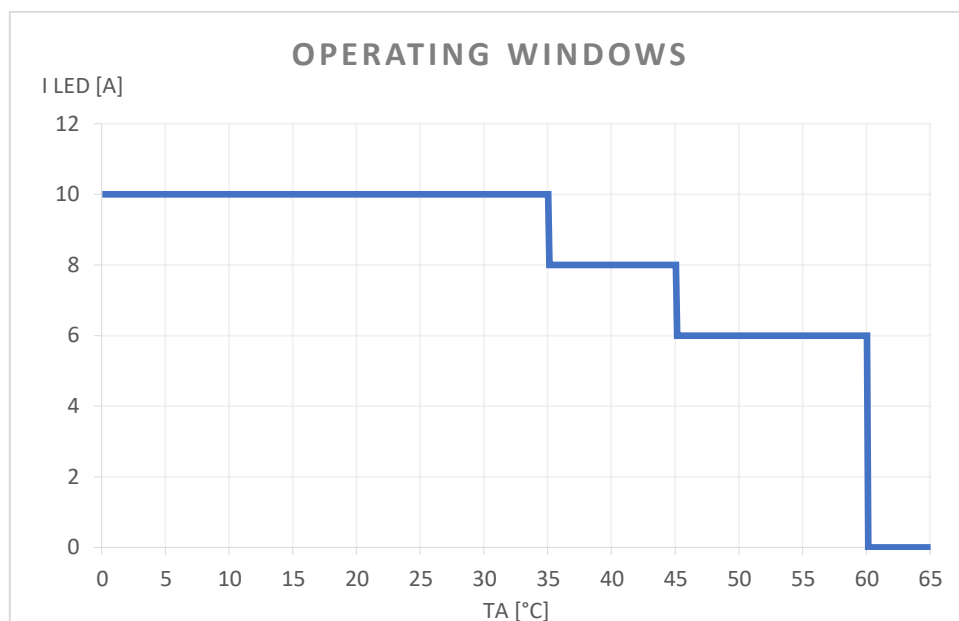

Below are the maximum current values that can be supplied by the MINI-1CV-DALI device when the working temperature varies. Ambient temperature [Ta]:

- ◆ - 10°C ÷ +35°C; Maximum current 10A
- ◆ +35°C ÷ +45°C; Maximum current 8A
- ◆ +45°C ÷ +60°C; Maximum current 6A

These maximum current values can be applied only under proper ventilation conditions.

FLICKER PERFORMANCE

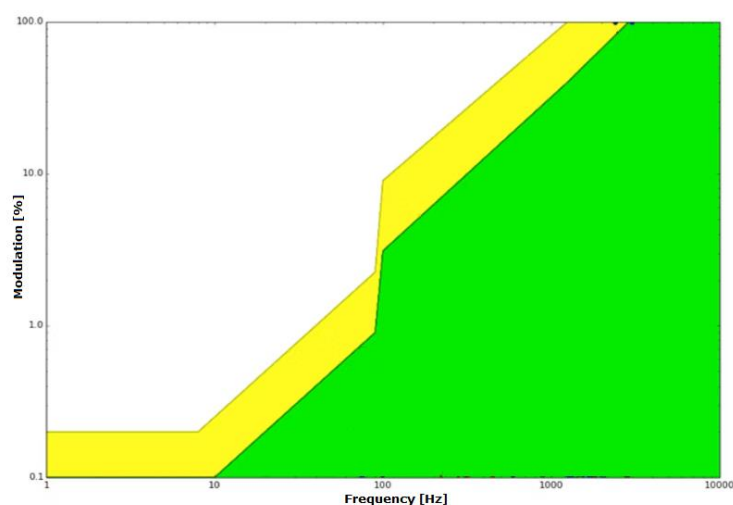

Thanks to the 4kHz dimming frequency the MINI-1CV-DALI allows to reduce the Flicker phenomenon.

Depending on the sensitivity of a person and the type of activity, flickering can affect a person's well-being even if the luminance fluctuations are above the threshold that can be perceived by the human eye.

The graph shows the phenomenon of Flickering in function at the frequency, measured throughout the dimming range.

The results show the low-risk zone (yellow) and the no-effect zone (green). Defined by IEEE 1789-2015⁶

⁶ Institute of Electrical and Electronics Engineers (IEEE). *IEEE std 1789: Recommended Practices for Modulating Current in High-Brightness LEDs for Mitigating Health Risks to Viewers.*

DIMMING CURVE

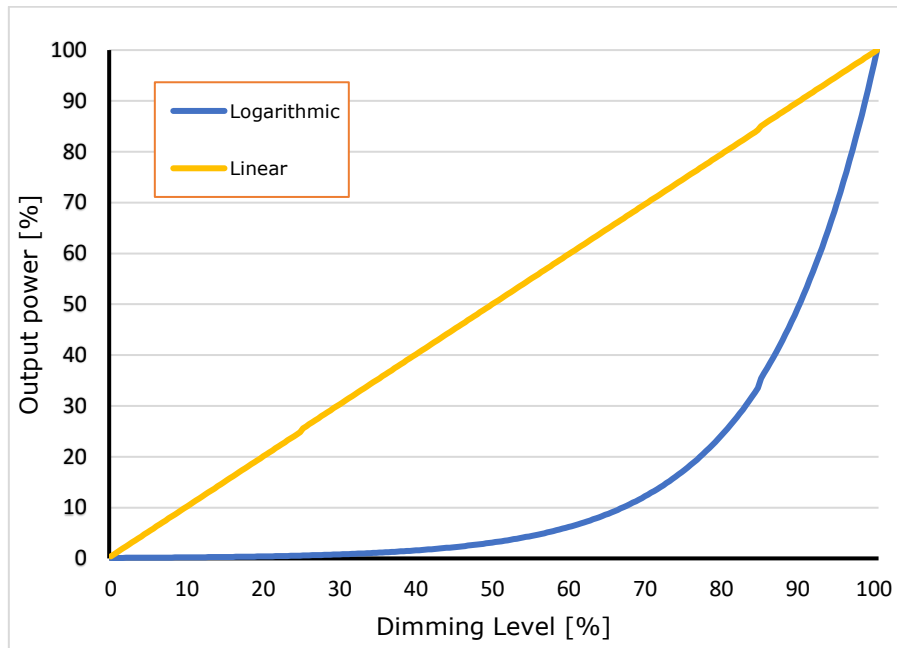

MECHANICAL DIMENSIONS

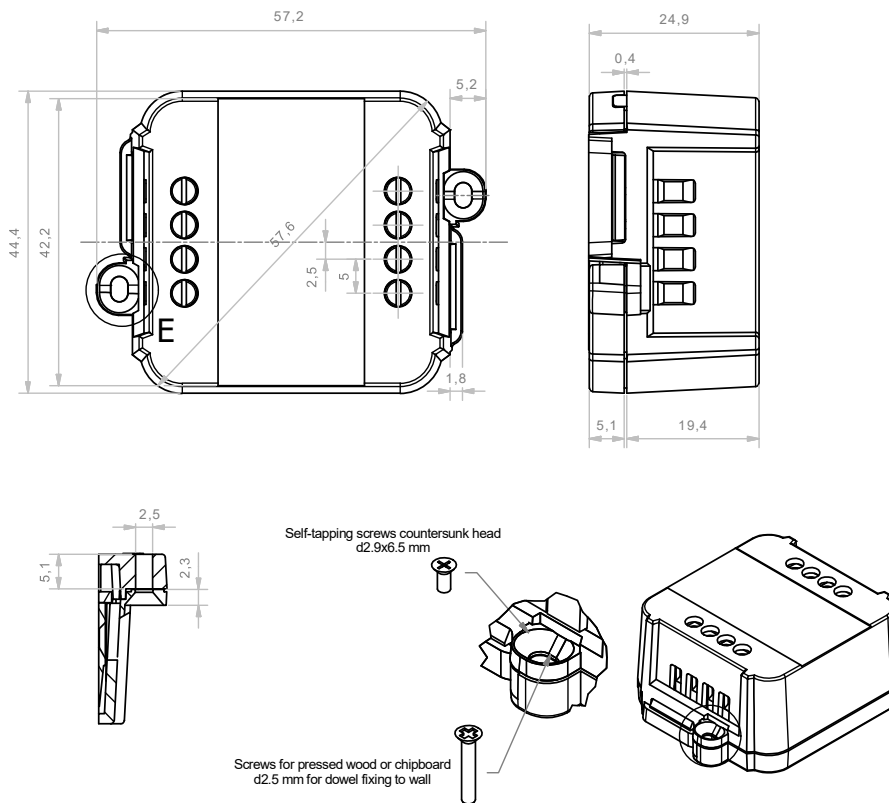

TECHNICAL NOTE

INSTALLATION

- **CAUTION:** The product may only be connected and installed by a qualified electrician. All applicable regulations, legislation, and building codes must be observed. Incorrect installation of the product can cause irreparable damage to the product and the connected LEDs.
- Maintenance must be performed only by a qualified electrician in compliance with current regulations.
Pay attention when connecting the LEDs: polarity reversal results in no light output and often damages the LEDs.
- The product is designed and intended to operate LED loads only. Powering non-LED loads may push the product outside its specified design limits and is, therefore, not covered by any warranty.
Operating conditions of the product may never exceed the specifications as per the product datasheet.
- The product must be installed inside a switchgear/controlgear cabinet and/or junction box protection against overvoltage.
- The product must be installed in a vertical or horizontal position with the label/top cover facing upwards or vertically. Other positions are not permitted. The bottom position is not permitted (label/top cover facing down).
- Keep separated 230Vac (LV) circuits and not SELV circuit from safety extra low voltage (SELV) circuit and from any connection with this product. It is absolutely forbidden to connect, for any reason whatsoever, directly or indirectly, the 230Vac mains voltage to the product (terminal block of BUS included).
- The product must be dissipated correctly.
- The use of the product in harsh environments could limit the output power.
- For built-in components inside luminaires, the t_a ambient temperature range is a guideline given for the optimum operating environment. However, integrator must always ensure proper thermal management (i.e. correct mounting of the device, air flow etc.) so that the t_c point temperature does not exceed the t_c maximum limit in any circumstance. Reliable operation and lifetime are only guaranteed if the maximum t_c point temperature is not exceeded under the conditions of use.

POWER SUPPLY

- Only use SELV power supplies with limited current for device power supply, short circuit protection and the power must be dimensioned correctly.
In the case of power supplies equipped with ground terminals, it is mandatory to connect ALL protective ground points (PE= Protection Earth) to a properly and certified protection earth.
- The connection cables between the very low voltage power source and the product must be properly dimensioned and must be insulated from any wiring or part at non-SELV voltage. It is recommended not to exceed 10m of connection between the power source and the product. Use double insulated cables.
- Dimension the power of the power supply in relation to the load connected to the device. In case the power supply is oversized compared to the maximum absorbed current, insert a protection against over-current between the power supply and the device.



COMMAND

- The length of the cables connecting between the local commands (N.O. Push button, 0-10V, 1-10V, Potentiometer or other) and the product must be less than 10m. The cables must be properly dimensioned and must be insulated from any non-SELV wiring or voltage. It is recommended to use double insulated cables, if deemed appropriate also shielded.
- The length and type of cables connecting to the bus (DALI or other) must comply with the specifications of the respective protocols and the regulations in force. They must be insulated from any non-SELV wiring or voltage parts. It is recommended to use double insulated cables.
- ALL device and control signal connected to the local command "N.O. Push button, potentiometer or other", they must not supply any type of voltage.
- ALL device and control signal connect at the BUS (DALI or other) and to the local command (0-10V, 1-10V, potentiometer or other) must be SELV type (the device connected must be SELV or supply SELV signal).

OUTPUTS

- It is recommended a length of the connecting cables between the product and the LED module less than 10m. The cables must be properly dimensioned and must be insulated from any wiring or circuits at voltage not SELV. It is recommended to use double insulated cables. In case you want to use connecting cables between the product and the LED module greater than 10m, the installer must guarantee the correct operation of the system. In any case, the connection between the product and the LED module must not exceed 30m.

SYMBOLOGIES

	All products are manufactured in compliance with European Directives, as reported in the EU Conformity Declaration.
	Independent lamp Controlgear: lamp controlgear consisting of one or more separate elements so designed that it can be mounted separately outside a luminaire, with protection according to the marking of the lamp controlgear and without any additional enclosure
SELV	"Safety Extra Low Voltage" in a circuit which is isolated from the mains supply by insulation not less than that between the primary and secondary circuits of a safety isolating transformer according to IEC 61558-2-6.
	At the end of its useful life the product described in this datasheet is classified as waste from electronic equipment, and cannot be disposed together with the municipal undifferentiated solid waste. Warning! Incorrect disposal of this product may cause serious damage to the environment and human health. Please be informed about the correct disposal procedures for waste collecting and processing provided by local authorities.

LIGHTAPP

START UP AND FIRST INSTALLATION

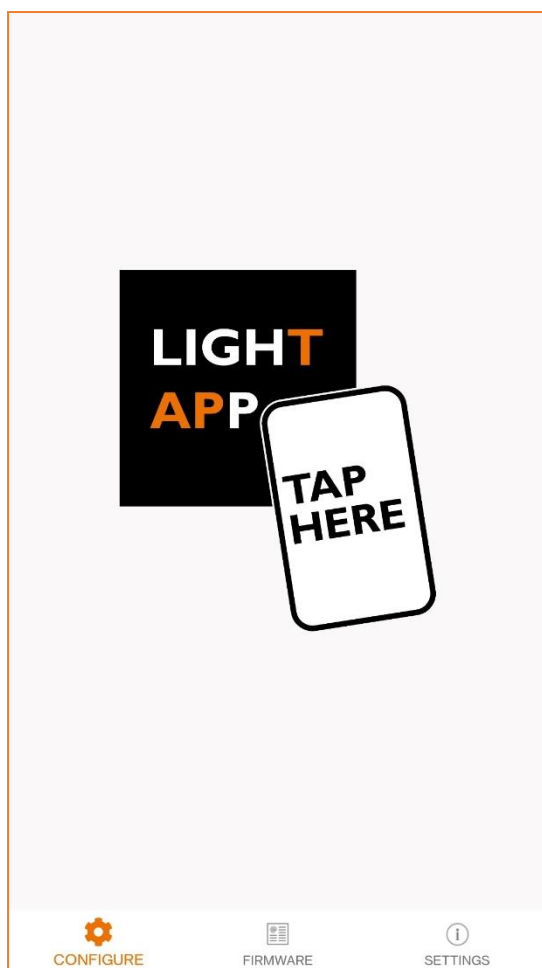

START SCREEN

On this screen, the app waits for the device parameters to be read.

To read the parameters, simply bring the back of the smartphone close to the device label. The read-sensitive area of the smartphone may vary depending on the model.

Once the connection is established, a quick loading screen will appear. It is necessary to stay in place with the smartphone until the parameters are fully loaded.

iOS variant: to read the parameters you need to press the SCAN button at the top right. A pop-up will appear indicating when the smartphone is ready to scan. Move the smartphone close to the device and stay in place until the parameters are fully loaded.

SETTINGS AND FIRMWARE LOADING PAGES



SETTINGS

Application	
Language	English
App version	1.0.0-20220726
Password to write	
The Company	
Address	Via Lago di Garda, Altavilla Vicentina, VI
	www.dalcnet.com

On the settings page you can set:

- ◆ App language
- ◆ Password: to be used for writing parameters.



FIRMWARE

Firmware upload



Choose a new firmware you want to upload to the device

SELECT A FILE

Max 10MB

On the firmware page, you can update the firmware of the device.

The requested file must be of type **.bin**.

Once the file is uploaded, follow the on-screen instructions.

ATTENTION:

- ◆ Once the procedure has begun, it is irrevocable and it is not possible to pause it.
- ◆ In case of interruption the firmware would be corrupted. In this case the device will need to repeat the loading procedure.
- ◆ At the end of the firmware loading, all previously set parameters will be reset to factory values.

If the update is successful and the loaded version is different from the previous one, the device will make 10 flashes

LOADING PARAMETERS

IMPORTANT: The writing of the parameters must be done with the device off (without input power).

WRITE

READ

READ

With the app in READ mode, the smartphone will scan the device and show its current configuration on the screen.

WRITE

With the app in WRITE mode, the smartphone will write the configuration of the parameters set on the screen inside the device.

Write all

Write all

In normal mode (*Write All Off*) the app writes only the parameters that have changed since the previous reading. In this mode, writing will only be successful if the serial number of the device matches the one previously read.

Write all

In *Write All* mode, all parameters are written. In this mode, writing will be successful only if the device model matches the one previously read.

It is recommended to activate the *Write All* mode only when you need to replicate the same configuration on many other devices of the same model.



WRITE PROTECTION

Using the padlock button, you can set a block when writing parameters. A screen for entering a 4-character password will appear. Once this password has been written to the device, all subsequent parameter changes can only be made if the correct password is written to the Settings page of the app.

To remove the password lock, simply press the padlock button and leave the Password field blank.

WRITING ERROR

If, after writing the parameters, when you turn it back on, the device flashes 2 times per second continuously, it means that the writing was not successful. Therefore, you need to perform the following steps:

- ◆ Turn off the device.
- ◆ Rewrite the parameters.
- ◆ Wait for the script to be successful or for no error messages to appear.
- ◆ Turn the device back on.

If it does not work, you can perform a factory reset by quickly turning the device off and on 6 times.

PRODUCTION INFORMATION

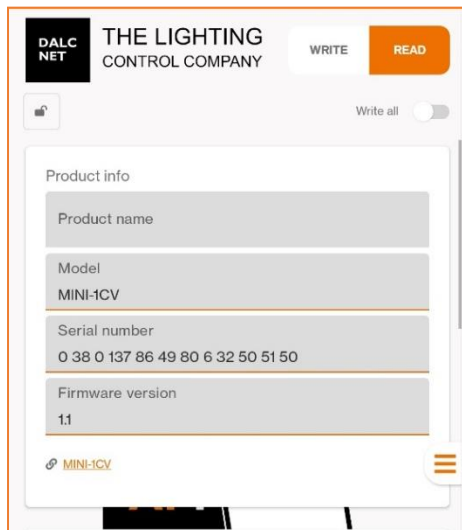

The screenshot shows a mobile application interface for DALCNET. At the top, there is a header with the DALCNET logo and 'THE LIGHTING CONTROL COMPANY'. Below this, there are 'WRITE' and 'READ' buttons. A 'Write all' toggle switch is visible. The main content area is titled 'Product info' and contains several fields: 'Product name' (empty), 'Model' (MINI-1CV), 'Serial number' (0 38 0 137 86 49 80 6 32 50 51 50), and 'Firmware version' (1.1). At the bottom, there is a 'MINI-1CV' label and a menu icon.

Product Name: User-settable field for easy identification. By default, the product name is the same as the Model field.

Template: An immutable field. Identifies the device model.

Serial number: This field cannot be edited. Uniquely identifies the specimen.

Firmware version: field not editable. Identifies the firmware version currently loaded on the device.

CONTROL SETTINGS

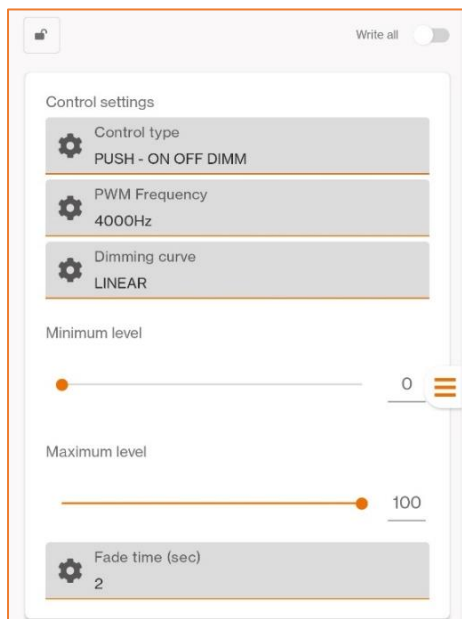

The screenshot shows a mobile application interface for DALCNET. At the top, there is a header with the DALCNET logo and 'THE LIGHTING CONTROL COMPANY'. Below this, there are 'WRITE' and 'READ' buttons. A 'Write all' toggle switch is visible. The main content area is titled 'Control settings' and contains several fields: 'Control type' (PUSH - ON OFF DIMM), 'PWM Frequency' (4000Hz), 'Dimming curve' (LINEAR), 'Minimum level' (0), 'Maximum level' (100), and 'Fade time (sec)' (2). At the bottom, there is a menu icon.

Control type: allows you to set the operating logic of the analog input in case of connection to a button or switch.

PWM frequency: allows you to set the frequency of PWM modulation of the output. NOTE: For applications in harsh thermal conditions, it is advisable to lower the PWM frequency to a minimum (307 Hz)

Dimming curve: For details, see the Dimming Curves section of the device manual

Fade time: The time in seconds that the output takes to make a transition from one level of light intensity to another.

CONTROL TYPES

PUSH – ON OFF DIM

The PUSH ON OFF DIM control type allows on/off and dimming by push-button

- ◆ Quick press: switch from On to Off or vice versa
- ◆ Long press: dimming
- ◆ Quick double press: instant on/off

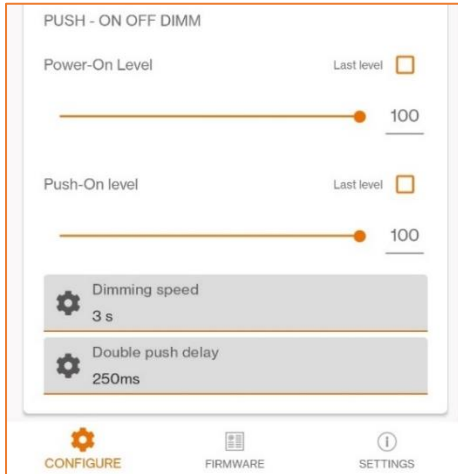

Power On level: it is the intensity value to which the output is brought immediately as soon as the device is powered.

Last level: Enable the memory function. The Power On level will correspond to the last level assumed before the supply voltage was removed.

Push-On level: it is the intensity value to which the output is brought when the device is accessed by means of a button.

Dimming speed: it is the time needed to dim the light from 100% to 0%

Last level: enables the memory function. The power level will correspond to the last level assumed before the device was turned off by button

Double-push delay: allows you to set the speed at which you need to perform the double-quick press.

DALI PARAMETERS

DALI parameters

DALI Address MASK

255

DALI dimming curve
logarithmic

Minimum level 1

Maximum level 254

Power-On Level MASK

254

System failure level MASK

254

Fade rate
44,7

Fade time
Extended fade time

Fast fade time
Fade time disabled

Ext fade time base value
1

Ext fade time multiplier
0s

Minimum fast fade time
0

Group 0 off
.
.
Group 15 off

Scene 0 MASK

255
.
.

Scene 15 MASK

255

Open circuit detection Enabled

Short circuit detection Enabled

SETTABLE COMMANDS FROM LIGHTAPP

Through the app you can set the following functions as shown in the reduced version of light app in the image:

- ◆ **DALI Address**
- ◆ **Dali Dimming Curve**
- ◆ **Minimum Level**
- ◆ **Maximum Level**
- ◆ **Power On Level**
- ◆ **System Failure Level**
- ◆ **Fade Rate**
- ◆ **Fade Time**
- ◆ **Fast Fade Time**
- ◆ **Ext Fade Base Value**
- ◆ **Ext Fade Time Multiplier**
- ◆ **Minimum Fast Fade Time**
- ◆ **Group 0-15: Associate an address with a group or multiple groups**
- ◆ **Scene 0-15: Creating a scene or scenes**
- ◆ **Open Circuit Detection**
- ◆ **Short Circuit Detection**

OPEN CIRCUIT AND SHORT CIRCUIT DETECTION

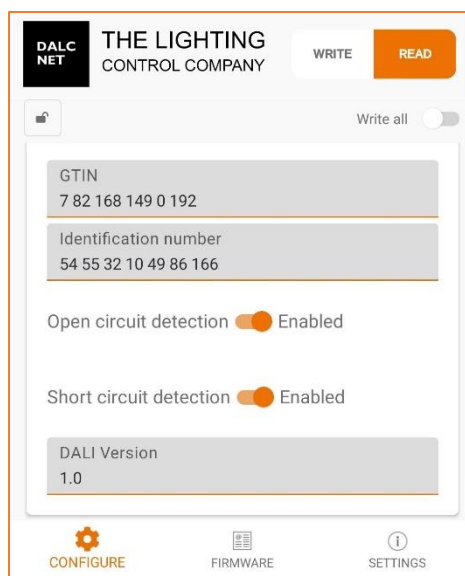

Through the Lamp-Failure command, the DALI protocol allows you to detect situations in which the LED load connected to the output of the MINI-1CV-DALI may not work as expected, such as an incorrect connection (detecting it as an Open Circuit error) or a defect in the LED load (detecting it as a short circuit).

Enable / Disable Open Circuit detection:

If a very small load is connected to the output of the MINI-1CV-DALI, in some cases false open circuits could be detected. In this case it is recommended to disable the Open Circuit function.

Enable / Disable the Short Circuit detection:

If inductive loads are connected to the output of the MINI-1CV-DALI, false short circuits may be detected in some cases. In this case it is recommended to disable the Short Circuit function.