



FEATURES

- ◆ DIMMER LED
- ◆ Power Supply: 12-24-48 Vdc
- ◆ Voltage Output for strip LED and LED module
- ◆ WHITE, MONOCOLOR, DYNAMIC WHITE, RGB, RGB+W, RGB+WW and RGB+TW Light Control
- ◆ BUS command:: DMX512-A+RDM
- ◆ Device configuration using Dalcnet LightApp mobile application
- ◆ Uscite in tensione costante per carichi R
- ◆ PWM modulation from 300 to 4000 Hz
- ◆ Parameters that can be set from APP and via RDM:
 - [PWM Frequency](#)
 - [Adjustment curve](#)
 - [Power On Levels](#)
 - [Personality DMX](#)
- ◆ Indication of operating hours and ignition cycles
- ◆ Short-circuit protection on LED outputs
- ◆ Opto-Isolated DMX Input
- ◆ Soft on/off
- ◆ Soft brightness dimming
- ◆ Extended temperature range
- ◆ 100% Functional test

PRODUCT DESCRIPTION

LINE-5CV-DMX is a 5-channel output LED dimmer, which can be controlled by means of a DMX BUS control. The LED dimmer is suitable for driving loads such as StripLEDs and LED modules, White, Single-color, Dynamic White, RGB, RGB+W, RGB+WW and RGB+TW at constant voltage. A 12-24-48 Vdc power supply can be connected. The maximum output current is 12A. The dimmerLED has the following protections: short-circuit protection on the LED outputs, over-power protection, reverse polarity protection, and input fuse protection.

Through the Dalcnet LightApp mobile application it is possible to configure multiple parameters of the LINE-5CV-DMX such as dimming frequency, dimming curve, max and min brightness level, etc.

LightApp can be downloaded free of charge from the Apple App Store and Google Play Store.

→ For the most up-to-date manual, please visit our website: www.dalcnet.com or the QR Code directly on your device.



PRODUCT CODE

CODE	POWER SUPPLY	OUTPUT LED	N° OF CHANNEL	BUS COMMAND	APP CONFIG
LINE-5CV-DMX	12-24-48 VDC	5 x 5A (max 12A) ¹	5	DMX512-RDM	APP: LIGHT APP

PROTECTIONS

OVP	Over-voltage protection ²		✓
RVP	Reverse polarity protection ²		✓
IFP	Protection with input fuse ²		✓
SCP	Short circuit protection		✓

REFERENCE STANDARDS

EN 55015	Limits and methods of measurement of radio disturbance characteristics of electrical lighting and similar equipment
EN 61547	Equipment for general lighting purposes – EMC immunity requirement
EN 61347-1	Lamp Controlgear – Part 1: General and safety requirement
EN 61347-2-13	Lamp Controlgear – Part 2-13: Particular requirement for d.c. or a.c. supplied electronic Controlgear for LED modules
ANSI E1.11	Entertainment Technology - USITT DMX512-A - Asynchronous Serial Digital Data Transmission Standard for Controlling Lighting Equipment and Accessories
ANSI E1.20	Entertainment Technology-RDM-Remote Device Management over USITT DMX512 Networks

¹ The maximum output current depends on the operating conditions and the ambient temperature of the installation. For the correct configuration, check the maximum power that can be delivered in the "[Specifiche Tecniche](#)" section.

² Protections refer to the control logic of the board.

TECHNICAL SPECIFICATIONS

		LINE 5CV DMX	
DC voltage range		Min: 10,8Vdc – Max: 52,8Vdc	
Output voltage		=Vin	
Supply current		Max 12A	
Output current³		5x max 5A	max 12A Totali
Nominal power	12 Vdc	60W	144W Tot.
	24 Vdc	120W	288W Tot.
	48 Vdc	240W	576W Tot.
Power loss in standby mode		< 0,5W	
Type of loads⁴		R	
Dimming curves⁵		Linear – Quadratic – Exponential	
Dimming method		Pulse Width Modulation "PWM"	
PWM Frequency⁵		307 – 667 – 1333 – 2000 – 4000 Hz	
PWM Resolution		16bit	
Storage Temperature		Min: -40°C – Max: 60°C	
Working ambient temperature, Ta³		Min: -10°C – Max: 60°C	
Type of connector		Morsetti Push-In	
Wiring section	Solid Size	0,2 ÷ 1,5 mm ² / 24 ÷ 16 AWG	
	Stranded Size		
Wire strip length		9 ÷ 10 mm	
IP protection grade		IP20	
Casing Material		Plastica	
Packaging units (pieces/units)		1pz	
Mechanical dimensions		186 x 29 x 21 mm	
Packaging dimensions		197 x 34 x 29 mm	
Weight		80g	

³ These maximum current values can only be applied under conditions of adequate ventilation.

⁴ Type of load: Resistive and DC/DC Converter.

⁵ The parameters are configured via LIGHTAPP.

WIRING DIAGRAM

Follow the steps below for product installation as shown in the connection diagram:

- **Load connection:** connect the LED load positive to terminal "L" with the "+" symbol, instead of the LED load negatives to terminals "L1", "L2", "L3", "L4" and "L5" with the "-" symbol.
- **DMX-RDM BUS connection:** connect the DATA+, DATA- and COM signal respectively to the "DMX" terminals with the "D+" "D-" "COM" symbols. Be sure not to connect live parts to the "INPUT" terminals.
- **Supply connection:** connect a 12-24-48 Vdc constant voltage SELV power supply (depending on the technical characteristics of the LED load) to the DC IN terminal with the "+" and "-" symbols. Make sure that you are not using a power supply with a constant current output and check that the polarity of the cables is correct.

CONNECTION DIAGRAM: PERSONALITY DIMMER & MACRO DIMMER

UP TO 5 WHITE OR MONOCHROME LOADS

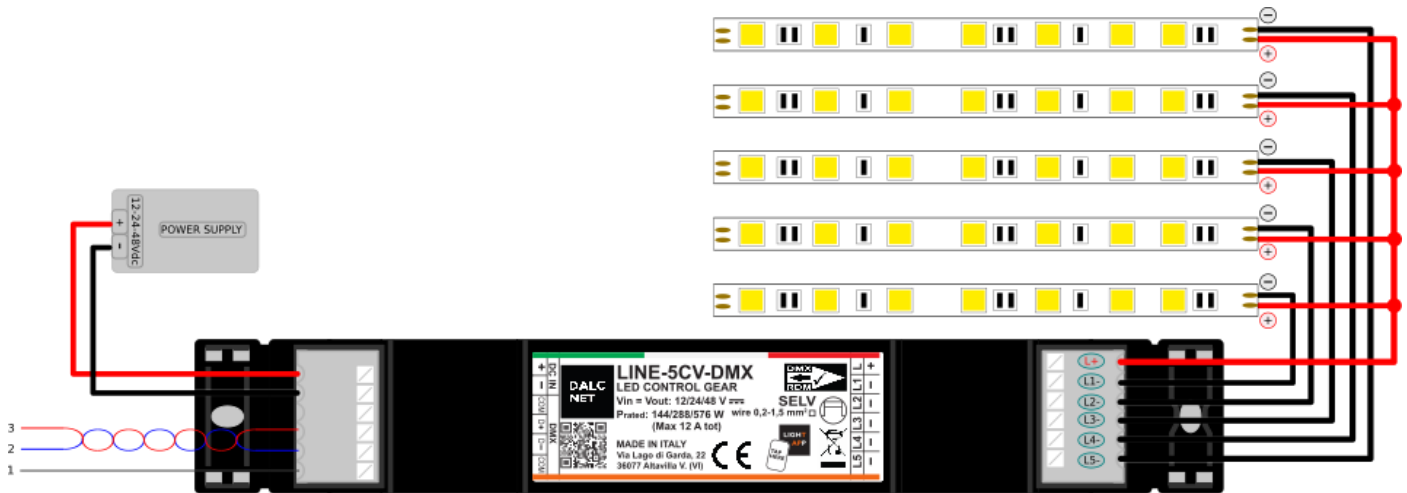

CONNECTION DIAGRAM: PERSONALITY DIM TO WARM & DYNAMIC WHITE

UP TO 2 LOADS DIM TO WARM OR DYNAMIC WHITE

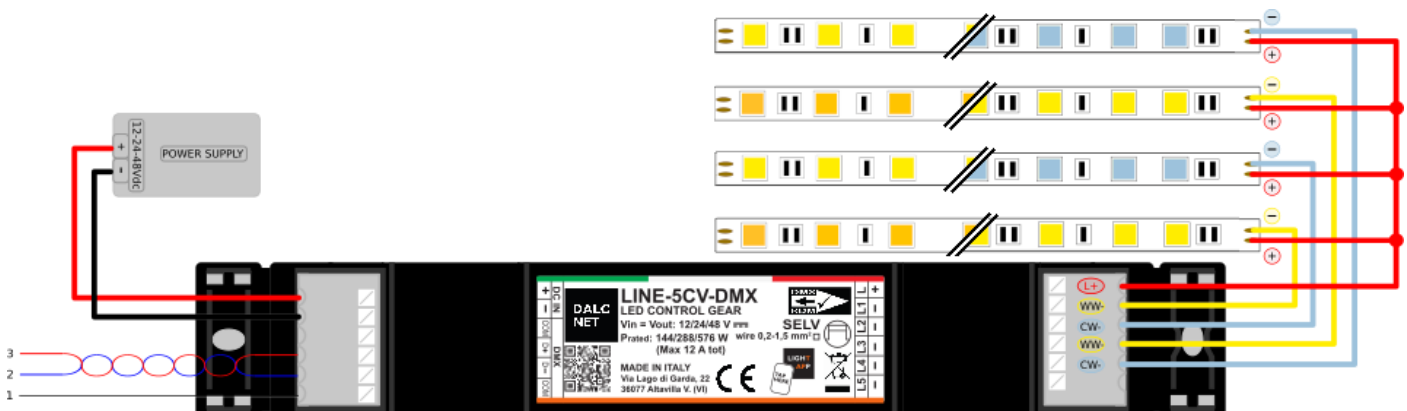

**PERSONALITY CONNECTION DIAGRAM: SMART HSI RGB & RGB & M+RGB+STROBE
CARICHI RGB**

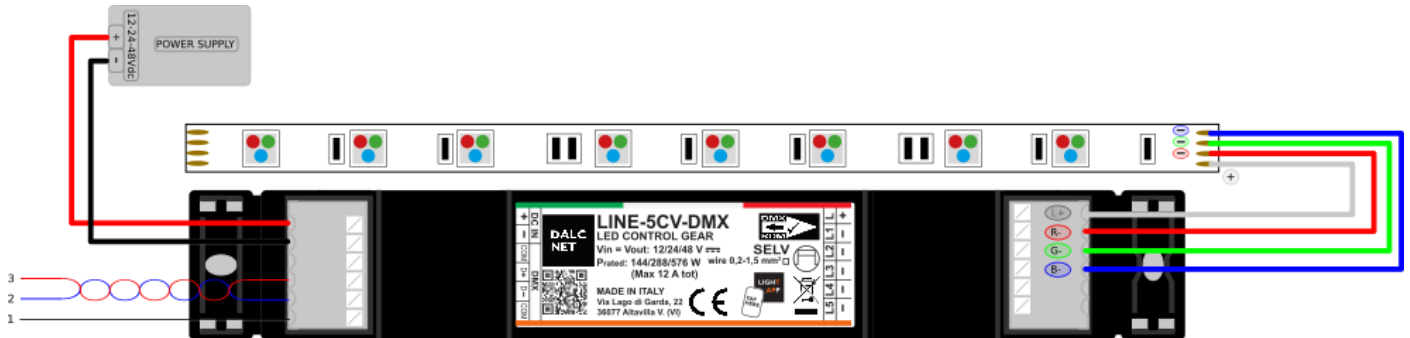

**PERSONALITY CONNECTION DIAGRAM: SMART HSI RGBW & RGBW & M+RGBW+STROBE
RGB+W LOADS**

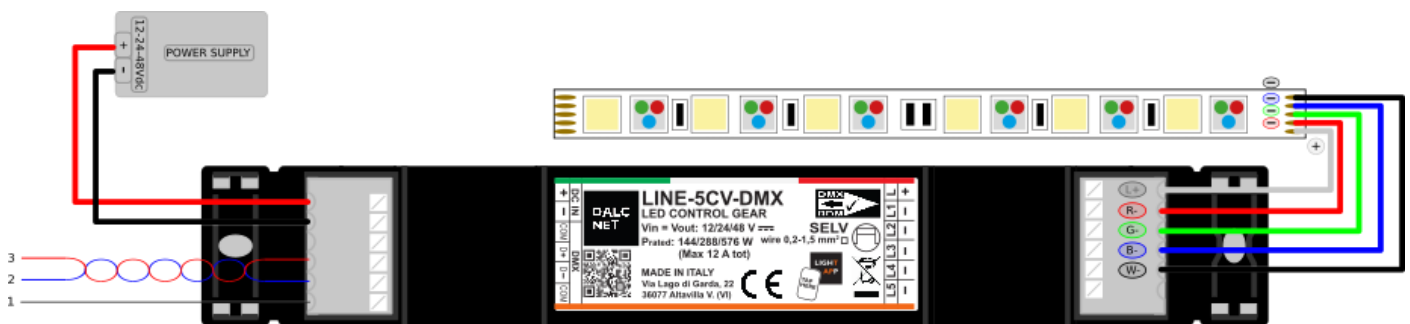

PERSONALITY CONNECTION DIAGRAM: SMART RGB+TW & RGB+TW LOADS

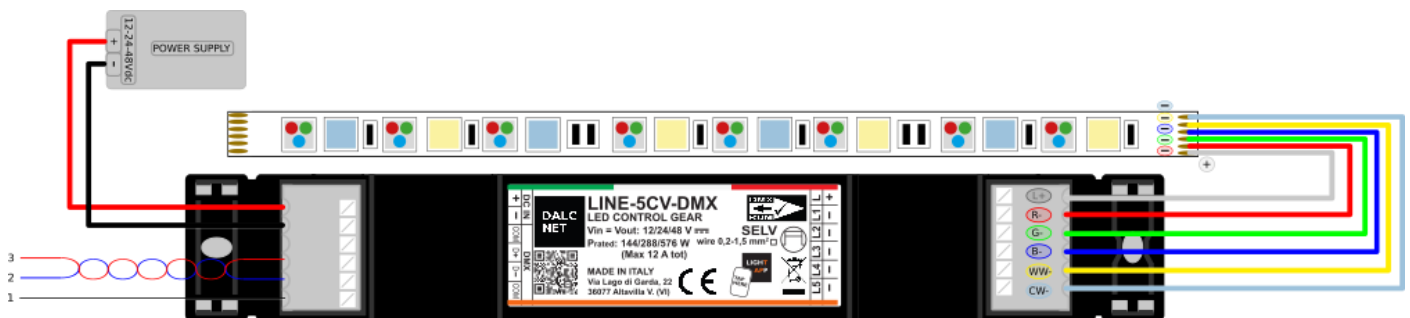

FLICKER PERFORMANCE

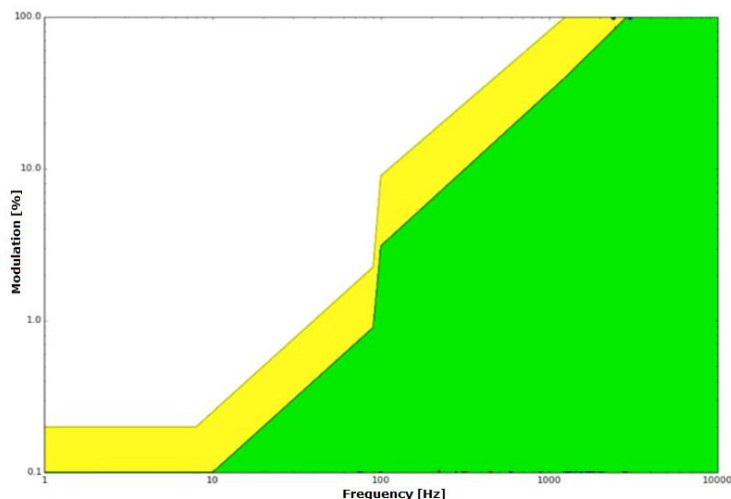

Thanks to its 4kHz dimming frequency, the LINE-5CV-DMX effectively reduces the occurrence of the Flicker phenomenon. Depending on an individual's sensitivity and the nature of their activities, flickering can impact one's well-being, even if the changes in luminance are beyond the threshold detectable by the human eye.

The graph shows the phenomenon of Flickering in function at the frequency, measured throughout the dimming range.

The results show the low-risk zone (yellow) and the no-effect zone (green). Defined by IEEE 1789-2015⁶

DIMMING CURVE

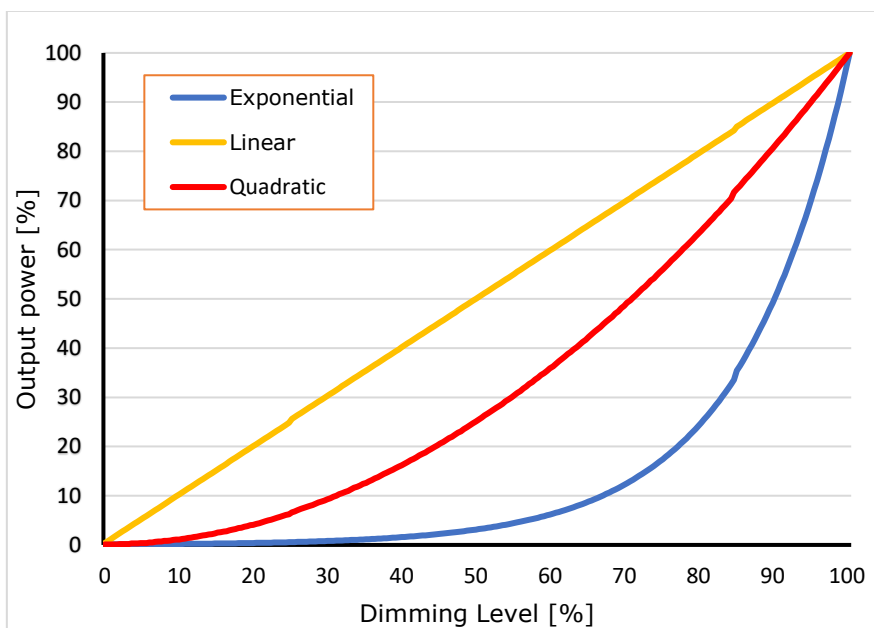

⁶ Institute of Electrical and Electronics Engineers (IEEE). *IEEE std 1789: Recommended Practices for Modulating Current in High-Brightness LEDs for Mitigating Health Risks to Viewers.*

DMX+RDM BUS OPERATION

WITH THE DMX+RDM "SLAVE" BUS MODE, THE OUTPUTS ARE MANAGED VIA AN EXTERNAL DMX CONTROL.

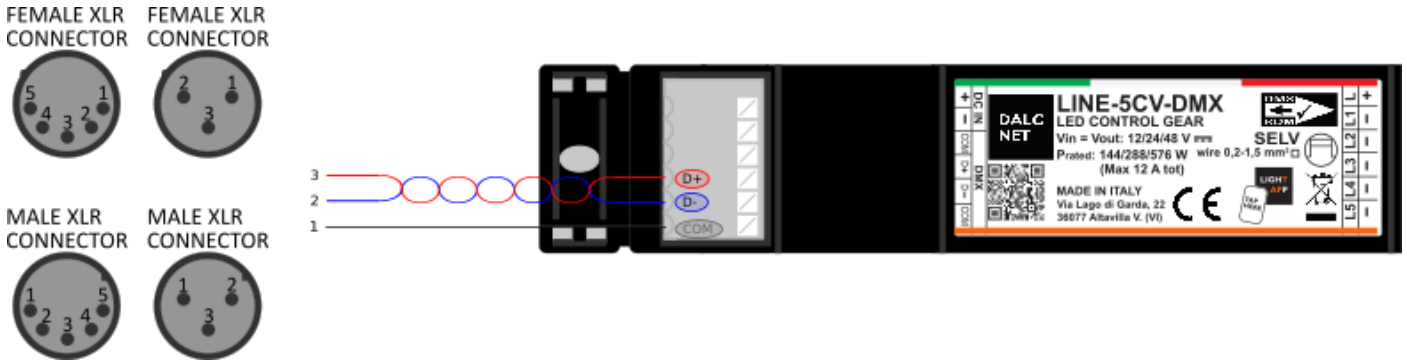

REFERENCE STANDARDS FOR THE DMX512+RDM BUS

ANSI E1.11	Entertainment Technology - USITT DMX512-A - Asynchronous Serial Digital Data Transmission Standard for Controlling Lighting Equipment and Accessories
ANSI E1.20	Entertainment Technology-RDM-Remote Device Management over USITT DMX512 Networks

PIN OUT 3 AND 5 PIN XLR CONNECTORS

USE	3-PIN XLR Pin #	5-PIN XLR Pin #	DMX512 Function
Common Reference	1	1	Data Link Common
Primary Data Link	2	2	Data 1-
	3	3	Data 1+
Secondary Data Link (Optional – see clause 4.8 of ANSI E1.11)		4	Data 2-
		5	Data 2+

CHANNELS MAP DMX512-RDM

DIMMER

DMX CHANNEL	FUNCTION	
1	DIMMER 1	DMX LEVEL 0...255
2	DIMMER 2	DMX LEVEL 0...255
3	DIMMER 3	DMX LEVEL 0...255
4	DIMMER 4	DMX LEVEL 0...255
5	DIMMER 5	DMX LEVEL 0...255

MACRO CANALE

DMX CHANNEL	FUNCTION	
1	MACRO DIMMER	DMX LEVEL 0...255

DIM TO WARM

DMX CHANNEL	FUNCTION	
1	DIM TO WARM 1	DMX LEVEL 0...255
2	DIM TO WARM 2	DMX LEVEL 0...255

BIANCO DINAMICO

DMX CHANNEL	FUNCTION	
1	DIMMER 1	DMX LEVEL 0...255
2	CORREZIONE TEMP. COLORE 1	DMX LEVEL 0...255
3	DIMMER 2	DMX LEVEL 0...255
4	CORREZIONE TEMP. COLORE 2	DMX LEVEL 0...255

SMART HSI RGB / SMART HSI RGBW

DMX CHANNEL	FUNCTION	
1	MASTER DIMMER	DMX LEVEL 0...255
2	CORREZIONE TEMP. COLORE	DMX LEVEL 0...255
3	HUE	DMX LEVEL 0...255
4	HUE ROTATION (RAINBOW) TIME	Hue Fine 0...15 Hold 16...25 30min 26...51 15min 52...76 6min 77...102 3min 103...127 1min 128...153 30s 154...179 15s 180...204 6s 205...230 3s 231...255
5	SATURAZIONE	DMX LEVEL 0...255
6	STROBO RATE	Fix 0...15 Blackout 16...31 1fps 32...47 2fps 48...63 3fps 64...79 4fps 80...95 5fps 96...111 6fps 112...127 7fps 128...143 8fps 144...159 9fps 160...175 10fps 176...191 12fps 192...207 14fps 208...223 16 fps 224...239 Fix 240...255



SMART HSI RGB+TW

DMX CHANNEL	FUNCTION																							
1	MASTER DIMMER RGB	DMX LEVEL 0...255																						
2	HUE	DMX LEVEL 0...255																						
3	HUE ROTATION (RAINBOW) TIME	<table border="1"> <tr> <td>Hue Fine</td> <td>Hold</td> <td>30min</td> <td>15min</td> <td>6min</td> <td>3min</td> <td>1min</td> <td>30s</td> <td>15s</td> <td>6s</td> <td>3s</td> </tr> <tr> <td>0...15</td> <td>16...25</td> <td>26...51</td> <td>52...76</td> <td>77...102</td> <td>103...127</td> <td>128...153</td> <td>154...179</td> <td>180...204</td> <td>205...230</td> <td>231...255</td> </tr> </table>	Hue Fine	Hold	30min	15min	6min	3min	1min	30s	15s	6s	3s	0...15	16...25	26...51	52...76	77...102	103...127	128...153	154...179	180...204	205...230	231...255
Hue Fine	Hold	30min	15min	6min	3min	1min	30s	15s	6s	3s														
0...15	16...25	26...51	52...76	77...102	103...127	128...153	154...179	180...204	205...230	231...255														
4	DIMMER TW	DMX LEVEL 0...255																						
5	CORREZIONE TEMP. COLORE	DMX LEVEL 0...255																						
6	CCT ROTATION	<table border="1"> <tr> <td>Hue Fine</td> <td>Hold</td> <td>60min</td> <td>30min</td> <td>12min</td> <td>6min</td> <td>2min</td> <td>1min</td> <td>30s</td> <td>12s</td> <td>6s</td> </tr> <tr> <td>0...15</td> <td>16...25</td> <td>26...51</td> <td>52...76</td> <td>77...102</td> <td>103...127</td> <td>128...153</td> <td>154...179</td> <td>180...204</td> <td>205...230</td> <td>231...255</td> </tr> </table>	Hue Fine	Hold	60min	30min	12min	6min	2min	1min	30s	12s	6s	0...15	16...25	26...51	52...76	77...102	103...127	128...153	154...179	180...204	205...230	231...255
Hue Fine	Hold	60min	30min	12min	6min	2min	1min	30s	12s	6s														
0...15	16...25	26...51	52...76	77...102	103...127	128...153	154...179	180...204	205...230	231...255														

RGB

DMX CHANNEL	FUNCTION	
1	DIMMER ROSSO	DMX LEVEL 0...255
2	DIMMER VERDE	DMX LEVEL 0...255
3	DIMMER BLU	DMX LEVEL 0...255

RGBW

DMX CHANNEL	FUNCTION	
1	DIMMER ROSSO	DMX LEVEL 0...255
2	DIMMER VERDE	DMX LEVEL 0...255
3	DIMMER BLU	DMX LEVEL 0...255
4	DIMMER BIANCO	DMX LEVEL 0...255

M+RGB+S

DMX CHANNEL	FUNCTION																	
1	MASTER DIMMER	DMX LEVEL 0...255																
2	DIMMER ROSSO	DMX LEVEL 0...255																
3	DIMMER VERDE	DMX LEVEL 0...255																
4	DIMMER BLU	DMX LEVEL 0...255																
5	STROBO	<table border="1"> <tr> <td>Fix</td> <td>Blackout</td> <td>1fps</td> <td>2fps</td> <td>3fps</td> <td>4fps</td> <td>5fps</td> <td>6fps</td> <td>7fps</td> <td>8fps</td> <td>9fps</td> <td>10fps</td> <td>12fps</td> <td>14fps</td> <td>16fps</td> <td>Fix</td> </tr> </table>	Fix	Blackout	1fps	2fps	3fps	4fps	5fps	6fps	7fps	8fps	9fps	10fps	12fps	14fps	16fps	Fix
Fix	Blackout	1fps	2fps	3fps	4fps	5fps	6fps	7fps	8fps	9fps	10fps	12fps	14fps	16fps	Fix			

M+RGBW+S

DMX CHANNEL	FUNCTION																	
1	MASTER DIMMER	DMX LEVEL 0...255																
2	DIMMER ROSSO	DMX LEVEL 0...255																
3	DIMMER VERDE	DMX LEVEL 0...255																
4	DIMMER BLU	DMX LEVEL 0...255																
5	DIMMER BIANCO	DMX LEVEL 0...255																
6	STROBO	<table border="1"> <tr> <td>Fix</td> <td>Blackout</td> <td>1fps</td> <td>2fps</td> <td>3fps</td> <td>4fps</td> <td>5fps</td> <td>6fps</td> <td>7fps</td> <td>8fps</td> <td>9fps</td> <td>10fps</td> <td>12fps</td> <td>14fps</td> <td>16fps</td> <td>Fix</td> </tr> </table>	Fix	Blackout	1fps	2fps	3fps	4fps	5fps	6fps	7fps	8fps	9fps	10fps	12fps	14fps	16fps	Fix
Fix	Blackout	1fps	2fps	3fps	4fps	5fps	6fps	7fps	8fps	9fps	10fps	12fps	14fps	16fps	Fix			

RDM SETTINGS

→ DMX START ADDRESS: DEVICE DMX CHANNEL SETTING.

Within the DMX START ADDRESS configuration, you can configure the DMX channel of the device.

→ DMX PERSONALITY: DEVICE MAP SETTINGS

Within the DMX PERSONALITY configuration it is possible to select the various maps of the LINE 5CV DMX, including:

- MACRO DIMMER
- DIM TO WARM
- TUNABEL WHITE
- SMART HSI RGB
- SMART HSI RGBW
- RGB
- RGBW
- MRGB+S
- MRGBW+S
- DIMMER
- SMART HSI RGBW+TW

→ DEVICE STATE: DEVICE OPERATION STATUS SETTINGS

Within the DEVICE STATE menu there is information on the operating hours and the on/off cycles of the device. These parameters are read-only and cannot be edited.

→ LAMP MENU: DEVICE POWER-ON STATUS SETTINGS

Within the LAMP MENU' menu it is possible to define "LAMP ON MODE", i.e. the status of the outputs when the device is switched on, whether it is 100% On or Off.

This function is only enabled in the absence of the DMX signal.

→ DIMMER MENU: DIMMING CURVE AND FREQUENCY SETTINGS OF THE DEVICE

Within the DIMMER MENU you can select the Linear, Quadratic or Exponential dimming curve and the dimming frequency 307, 667, 1333, 2000 or 4000 Hz.

RDM COMMANDS

REQUESTED PARAMETERS	
DISC_UNIQUE_BRANCH	✓
DISC_MUTE	✓
DISC_UN_MUTE	✓
SUPPORTED_PARAMETERS	✓
PARAMETER_DESCRIPTION	✓
DEVICE_INVO	✓
DMX_START_ADDRESS	✓
IDENTIFY_DEVICE	✓

SUPPORTED PARAMETERS	
PRODUCT_DETAIL_ID_LIST	✓
DEVICE_MODEL_DESCRIPTION	✓
MANUFACTURER_LABEL	✓
DEVICE_LABEL	✓
BOOT_SOFTWARE_VERSION_ID	✓
BOOT_SOFTWARE_VERSION_LABEL	✓
DMX_PERSONALITY	✓
DMX_PERSONALITY_DESCRIPTION	✓
SLOT_INFO	✓
SLOT_DESCRIPTION	✓
DEFAULT_SLOT_VALUE	✓
DEVICE_HOURS	✓
LAMP_ON_MODE	✓
DIMMER_INFO	✓
CURVE	✓
CURVE_DESCRIPTION	✓
MODULATION_FREQUENCY	✓
MODULATION_FREQUENCY_DESCRIPTION	✓

MECHANICAL DIMENSIONS

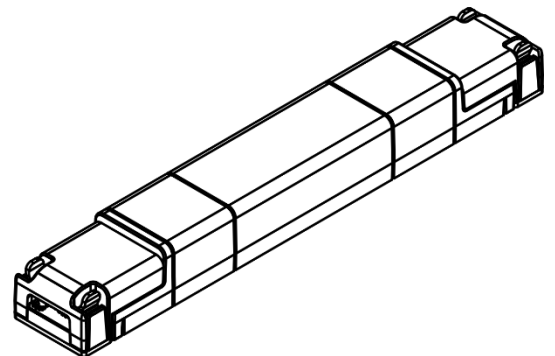
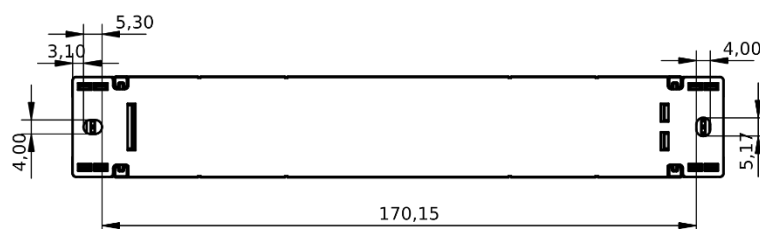
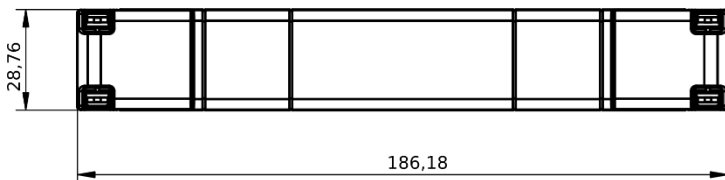
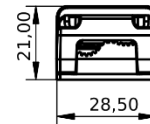
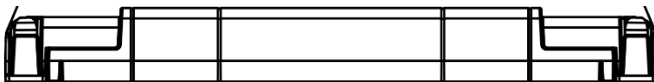

TECHNICAL NOTE

INSTALLATION

- **CAUTION:** The product may only be connected and installed by a qualified electrician. All applicable regulations, legislation, and building codes must be observed. Incorrect installation of the product can cause irreparable damage to the product and the connected LEDs.
Use caution when connecting LEDs. Polarity reversal results in no light output and can often damage the LEDs.
- Maintenance must only be carried out by qualified personnel in compliance with current regulations.
The product is designed and intended to operate LED loads only. Powering non-LED loads may push the product outside its specified design limits and is, therefore, not covered by any warranty.
Operating conditions of the product may never exceed the specifications as per the product datasheet.
- The product must be installed inside a switchgear/controlgear cabinet and/or junction box protection against overvoltage.
- The product must be installed in a vertical or horizontal position with the label/top cover facing upwards or vertically. Other positions are not permitted. The bottom position is not permitted (label/top cover facing down).
- Keep separated 230Vac (LV) circuits and not SELV circuit from safety extra low voltage (SELV) circuit and from any connection with this product. It is absolutely forbidden to connect, for any reason whatsoever, directly or indirectly, the 230Vac mains voltage to the product (terminal block of BUS included).
- The product must be dissipated correctly.
- The use of the product in harsh environments could limit the output power.
- For built-in components inside luminaires, the ta ambient temperature range is a guideline given for the optimum operating environment. However, integrator must always ensure proper thermal management (i.e. correct mounting of the device, air flow etc.) so that the tc point temperature does not exceed the tc maximum limit in any circumstance. Reliable operation and lifetime is only guaranteed if the maximum tc point temperature is not exceeded under the conditions of use.

POWER SUPPLY

- Only use SELV power supplies with limited current for device power supply, short circuit protection and the power must be dimensioned correctly.
In the case of power supplies equipped with ground terminals, it is mandatory to connect ALL protective ground points (PE= Protection Earth) to a properly and certified protection earth.
- The connection cables between the very low voltage power source and the product must be properly dimensioned and must be insulated from any wiring or part at non-SELV voltage. Use double insulated cables.
- Dimension the power of the power supply in relation to the load connected to the device. In case the power supply is oversized compared to the maximum absorbed current, insert a protection against over-current between the power supply and the device.



COMMANDS:

- The length of the cables connecting between the local commands (N.O. Push button or other) and the product must be less than 10m. The cables must be properly dimensioned and must be insulated from any non-SELV wiring or voltage. It is recommended to use double insulated cables, if deemed appropriate also shielded.
- All devices and control signals connected to the buses (DMX512 or other) must be of the SELV type (the connected devices must be SELV or in any case provide a SELV signal).

OUTPUTS:

- It is recommended that the length of the connection cables between the product and the LED module is less than 3m. Cables must be properly sized and should be insulated from any non-SELV wiring or parts. It is recommended to use double-insulated cables. If you want to use connection cables between the product and the LED module longer than 3m, the installer must ensure the correct operation of the system. In any case, the connection between the product and the LED module must not exceed 30m.

SYMBOLOGIES

	All products are manufactured in compliance with European Directives, as reported in the EU Conformity Declaration.
	Independent lamp Controlgear: lamp controlgear consisting of one or more separate elements so designed that it can be mounted separately outside a luminaire, with protection according to the marking of the lamp controlgear and without any additional enclosure
SELV	"Safety Extra Low Voltage" in a circuit which is isolated from the mains supply by insulation not less than that between the primary and secondary circuits of a safety isolating transformer according to IEC 61558-2-6.
	At the end of its useful life the product described in this datasheet is classified as waste from electronic equipment, and cannot be disposed together with the municipal undifferentiated solid waste. Warning! Incorrect disposal of this product may cause serious damage to the environment and human health. Please be informed about the correct disposal procedures for waste collecting and processing provided by local authorities.

LIGHTAPP

START-UP AND FIRST INSTALLATION

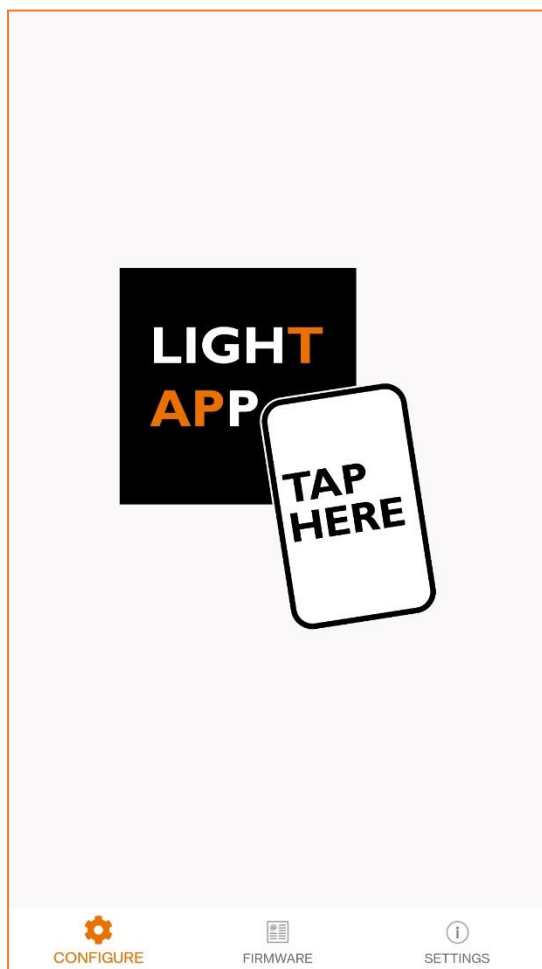

STARTUP SCREEN

On this screen, the app waits for the device parameters to be read.

To read the parameters, simply bring the back of the smartphone close to the device's label. The read-sensitive zone of the smartphone may vary depending on the model.

Once the connection is established, a quick loading screen will appear. You must remain in position with your smartphone until the parameters are fully loaded.

iOS variant: To read the parameters, you need to press the SCAN button at the top right. A pop-up will appear indicating when your smartphone is ready to scan. Move the smartphone closer to the device and remain in place until the parameters are fully loaded.

SETTINGS AND FIRMWARE LOADING SCREENS



SETTINGS

Application	
Language	English
App version	1.0.0-20220726
Password to write	
The Company	
Address	Via Lago di Garda, Altavilla Vicentina, VI
	www.dalcnet.com

On the settings page you can set:

- ◆ App language
- ◆ Password: To be used for writing parameters.



FIRMWARE

Firmware upload



Choose a new firmware you want to upload to the device

SELECT A FILE

(Max 10MB)

On the firmware page, you can update the firmware of the device.

The requested file must be of type ***.bin**.

Once the file is uploaded, follow the on-screen instructions.

ATTENTION:

- ◆ **Once the procedure has begun, it is irrevocable and it is not possible to pause it.**
- ◆ **In case of interruption the firmware would be corrupted. In this case the device will need to repeat the loading procedure.**
- ◆ **At the end of the firmware loading, all previously set parameters will be reset to factory values.**

If the update is successful and the loaded version is different from the previous one, the device will make 10 flashes

LOADING PARAMETERS

IMPORTANT: The writing of the parameters must be done with the device off (without input power).

WRITE

READ

READ

With the app in READ mode, the smartphone will scan the device and show its current configuration on the screen.

WRITE

With the app in WRITE mode, the smartphone will write the configuration of the parameters set on the screen inside the device.

Write all

Write all

In normal mode (*Write All Off*) the app writes only the parameters that have changed since the previous reading. In this mode, writing will only be successful if the serial number of the device matches the one previously read.

Write all

In *Write All* mode, all parameters are written. In this mode, writing will be successful only if the device model matches the one previously read.

It is recommended to activate the *Write All* mode only when you need to replicate the same configuration on many other devices of the same model.



WRITE PROTECTION

Using the padlock button, you can set a block when writing parameters. A screen for entering a 4-character password will appear. Once this password has been written to the device, all subsequent parameter changes can only be made if the correct password is written to the Settings page of the app.

To remove the password lock, simply press the padlock button and leave the Password field blank.

WRITING ERROR

If, after writing the parameters, when you turn it back on, the device flashes 2 times per second continuously, it means that the writing was not successful. Therefore, you need to perform the following steps:

- ◆ Turn off the device.
- ◆ Rewrite the parameters.
- ◆ Wait for the script to be successful or for no error messages to appear.
- ◆ Turn the device back on.

If it does not work, you can perform a factory reset by quickly turning the device off and on 6 times.

PRODUCT INFORMATION

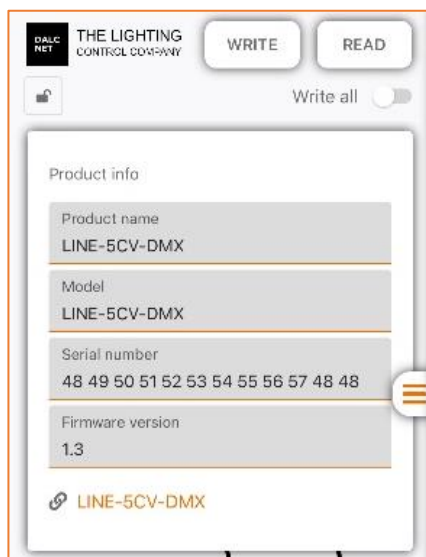

Product Name: User-settable field for easy identification. By default, the product name is the same as the Model field.

Model: An immutable field. Identifies the device model.

Serial number: This field cannot be edited. Uniquely identifies the specimen.

Firmware version: field not editable. Identifies the firmware version currently loaded on the device.

IMPOSTAZIONI DI CONTROLLO

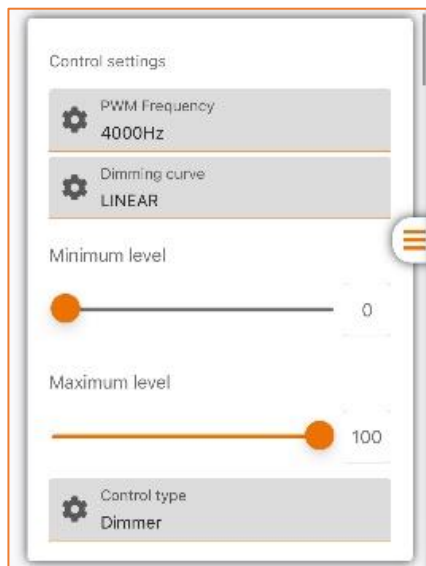

PWM frequency: allows you to set the frequency of PWM modulation of the output. NOTE: For applications in harsh thermal conditions, it is advisable to lower the PWM frequency to a minimum (307 Hz)

Dimming curve: For details, see the Dimming Curves section of the device manual

Control type: Selection of the control map (see next paragraph).

CONTROL TYPES

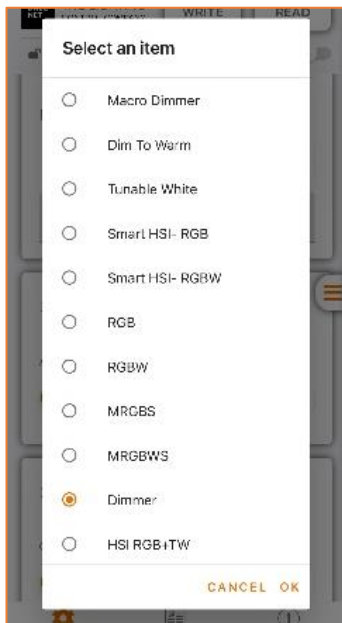

Within the "Control Type" configuration it is possible to select the various maps of the LINE-5CV-DMX, including:

- ◆ MACRO DIMMER
- ◆ DIM TO WARM
- ◆ TUNABLE WHITE
- ◆ SMART HSI-RGB
- ◆ SMART HSI-RGBW
- ◆ RGB
- ◆ RGBW
- ◆ MRGB+S
- ◆ MRGBW+S
- ◆ DIMMER
- ◆ SMART HSI RGBW+TW

DMX ADDRESSING

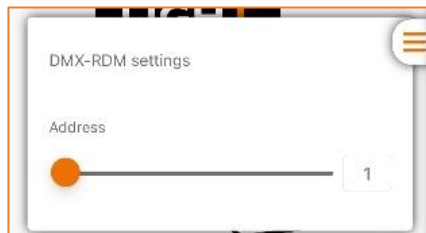

For each type of control, the DMX address of the device can be defined within the range (0 ÷ 512).

POWER-ON SETTINGS

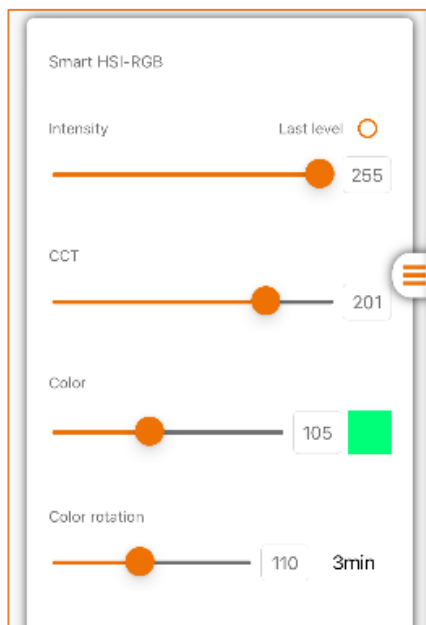

Depending on the type of control selected ("Smart HSI-RGB" in the example image) for each output channel it is possible to set the initial switch-on level: during power-up and in the absence of the DMX signal, the device will bring the outputs to the levels set in this section.

It is also possible to set the memorization of the last level available during the shutdown phase (e.g. in case of power failure), by selecting the "Last Level" option: in this case, during the switch-on and in the absence of the DMX signal, the device will bring the outputs to the levels stored during the shutdown phase.

For more information on output channel configurations and levels, refer to the "DMX512-RDM Channel Maps" section of this manual.