



### FEATURES

- 4 Relay Driver output
- Input: DC 12/24/48 Vdc
- BUS Command: DMX512-A/RDM, DALI, MODBUS
- LOCAL Command: 4x N.O. push button (with or without memory), 0-10V, 1-10V e Potenziometro
- Controls: ON/OFF di relè di potenza (optional)
- Typical efficiency >95%
- Extended di temperature range
- 100% Functional test – 5 years warranty

➔ For whole and updated **Device Manual** refer to producer's <http://www.dalcnet.com>

#### ➤ Relay Driver

CODE	Supply voltage	Output	Channels	Command
DLD1248-4RL-DALI	12/24/48V DC	4 x 500mA max	4	DALI 4xN.O. push button / 0÷10 / 1÷10 / Pot 22kOhm
DLD1248-4RL-DMX	12/24/48V DC	4 x 500mA max	4	DMX512-A/RDM 4xN.O. push button / 0÷10 / 1÷10 / Pot 22kOhm
DLD1248-4RL-MODBUS	12/24/48V DC	4 x 500mA max	4	MODBUS 4xN.O. push button / 0÷10 / 1÷10 / Pot 22kOhm

#### ➤ Protections

		DLD1248-4CV
<b>OTP</b>	Over temperature protection <sup>1</sup>	✓
<b>OVP</b>	Over voltage protection <sup>2</sup>	✓
<b>UVP</b>	Under voltage protection <sup>2</sup>	✓
<b>RVP</b>	Reverse polarity protection <sup>2</sup>	✓
<b>IFP</b>	Input fuse protection <sup>2</sup>	✓
<b>SCP</b>	Short circuit protection	✓
<b>OCP</b>	Open circuit protection	✓
<b>CLP</b>	Current limit protection	✓

<sup>1</sup> Output thermal shutdown with over temperature. Thermal shutdown is take on with transistor (>150°C)

<sup>2</sup> Control logic protection



### ➤ Reference Standards

EN 61347-1	Lamp controlgear – Part 1: General and safety requirements
EN 55015	Limits and methods of measurement of radio disturbance characteristics of electrical lighting and similar equipment
EN 61547	Equipment for general lighting purposes – EMC immunity requirements
EN 50581	Technical documentation for the assessment of electrical and electronic products with respect to the restriction of hazardous substances
IEC/EN 62386-101	Digital addressable lighting interface – Part 101: General requirements - System
IEC/EN 62386-102	Digital addressable lighting interface – Part 102: General requirements – Control gear
IEC/EN 62386-207	Digital addressable lighting interface – Part 207: Particular requirements for control gear – LED modules (device type 6)
IEC 60929-E.2.1	Control interface for controllable ballasts – control by d.c. voltage – functional specification
ANSI E 1.3	Entertainment Technology – Lighting Control Systems – 0 to 10V Analog Control Specification
ANSI E1.11	Entertainment Technology – USITT DMX512-A – Asynchronous Serial Digital Data Transmission Standard for Controlling Lighting Equipment and Accessories
ANSI E1.20	Entertainment Technology-RDM-Remote Device Management over USITT DMX512 Networks
-	MODBUS APPLICATION PROTOCOL SPECIFICATION V1.1b

### ➤ Technical Specification

	Relay Driver version
Supply voltage (Vin)	Min: 10.8 Vdc .. max 52.8 Vdc
Output voltage	= Vin
External Range Relè, for channel <sup>3</sup>	Vin, max 500mA/ch <sup>3</sup>
Thermal shutdown	135 °C
Power loss in standby mode	<500mW
Storage Temperature	min: -40 max: +60 °C
Ambient Temperature <sup>4</sup>	min: -10 max: +40 °C
Protection Grade	IP10
Button & Bus Wiring	1.5mm <sup>2</sup> solid – 1mm <sup>2</sup> stranded – 30/14 AWG
Power & Leds Wiring	2.5mm <sup>2</sup> solid – 1.5mm <sup>2</sup> stranded – 30/12 AWG
Mechanical Dimension	71 x 91 x 62 mm – DIN RAIL 4M
Packaging Dimension	124 x 85 x 71 mm
Casing Material	Plastic
Weight	125g

<sup>3</sup> maximum value of relay coil excitation voltage, must be dimensioned correctly respect supply voltage

<sup>4</sup> maximum value, dependent on the ventilation condition

### ➤ Installation

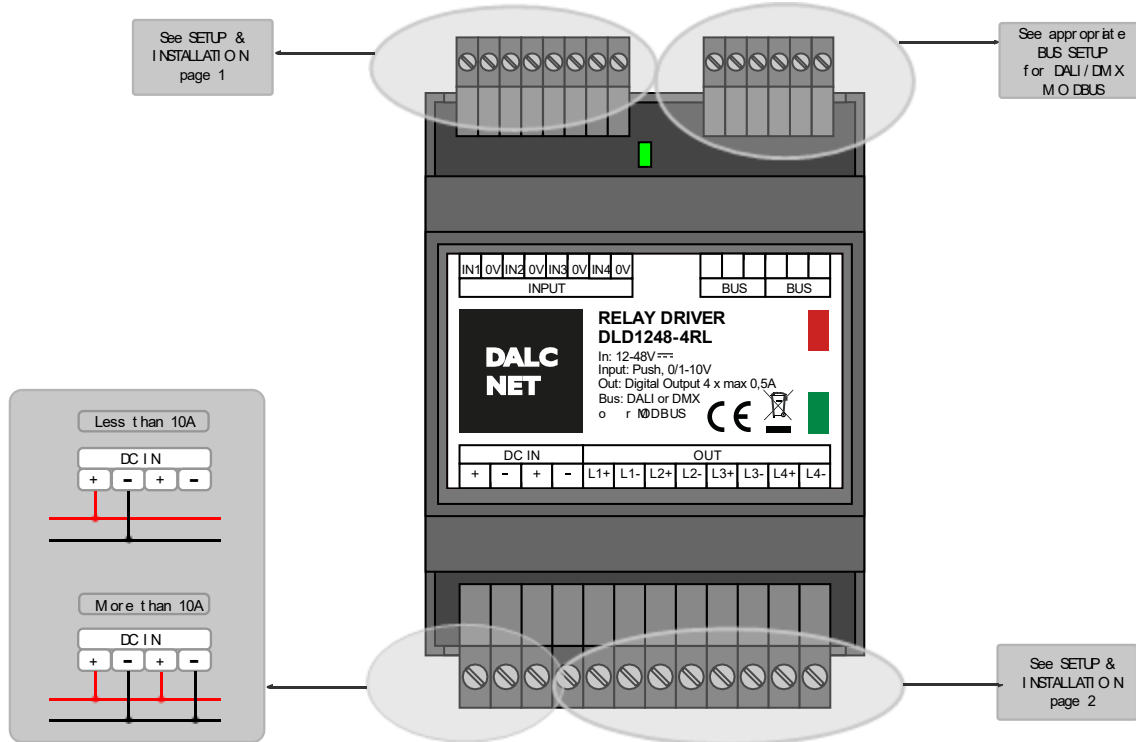

### Mechanical dimension:

(without connectors)

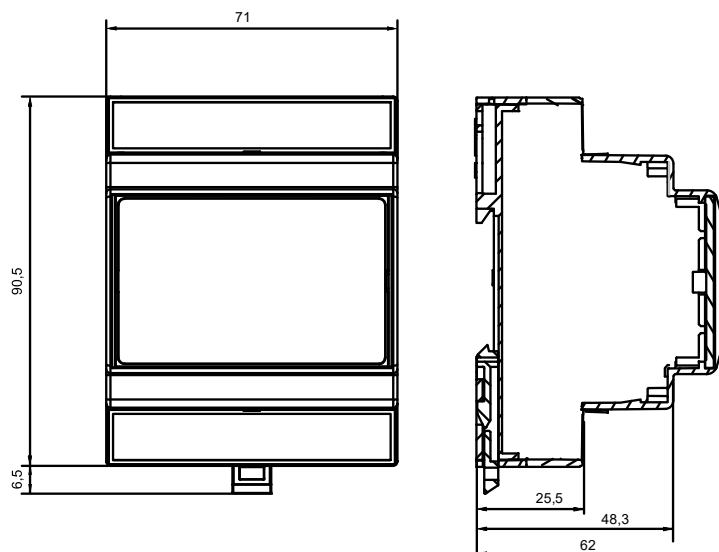

## Opening the cover

For the Dip-switch and selectors configuration it is necessary to pull up the cover of the device. See the picture.

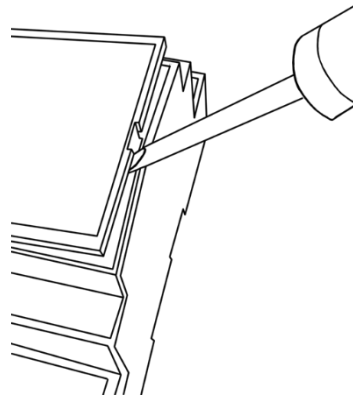

## TECHNICAL NOTES

### Installation:

- Installation and maintenance must be performed only by qualified personnel in compliance with current regulations.
- The product must be installed inside an electrical panel protected against overvoltages.
- The product must be installed in a vertical or horizontal position with the cover / label upwards or vertically; other positions are not permitted. It is not permitted to bottom-up position (with the cover / label updown).
- Keep separated the circuits at 230V (LV) and the circuits not SELV from circuits to low voltage (SELV) and from any connection with this product. It is absolutely forbidden to connect, for any reason whatsoever, directly or indirectly, the 230V mains voltage to the bus or to other parts of the circuit.

### Power Supply:

- For the power supply use only a SELV power supplies with limited current, short circuit protection and the power must be dimensioned correctly. In case of using power supply with ground terminals, all points of the protective earth (PE = Protection Earth) must be connected to a valid and certified protection earth.
- The connection cables between the power source "low voltage" and the product must be dimensioned correctly and they should be isolated from every wiring or parts at voltage not SELV. Use double insulated cables..

### Comandi:

- The lenght and type of the connection cables at the BUS (DMX512 or other) use cables as the specification of the respective protocols and regulations and they should be isolated from every wiring or parts at voltage not SELV. It is suggested to use double insulated shielded and twisted cales
- All the product and the control signal connect at the bus (DMX512 or other) must be SELV (the devices connected must be SELV or supply a SELV signal).

### Output:

- The length of the connection cables between the product and the power relay, must be less than 10m; the cables must be dimensioned correctly and they should be isolated from every wiring or parts at voltage not SELV. Is preferable to use shielded and twisted cables.

### In case

- Relay coil excitation voltage must be dimensioned correctly respect supply voltage (optional relay)



### ➤ SETUP & INSTALLATION

A 12 wat dip-switch (under the cover) can provide a rich set of possible local commands:

Function		<ul style="list-style-type: none"> <li>Switches from 1 to 8:</li> <li>Switches from 9 to 10:</li> <li>Switches from 11 to 12:</li> </ul>	<b>Reserved Input Type Reserved</b>
	Res. Res. Res. Input Res.		
	Note: Factory positions = all OFF		

#### 1) Select Input Type: Switches from 9 to 10

In Type	Description	Connections	Setting
Push	N.O. push button NO MEMORY		
	N.O. push button MEMORY		
0-10V	Analogic 0-10V	0..10V 0..10V 0..10V 0..10V 	
1-10V	Analogic 1-10V & Potenziometer	1..10V 1..10V 1..10V 1..10V 	

#### 2) Output

OUTPUT RELAY DRIVER <sup>5</sup>	Driver Relay

<sup>5</sup> example of connection between Relay driver outs and power relay



## ➤ LOCAL COMMANDS

COMMANDS: N.O. push button NO MEMORY / N.O. push button MEMORY

Set DIP 9 and 10 following SETUP &amp; INSTALLATION at page 5 to use local input N.O. push button

Ch.	Function	Value
1	ON/OFF ch1	Click ON (turn ON) Click OFF (turn OFF)
2	ON/OFF ch2	Click ON (turn ON) Click OFF (turn OFF)
3	ON/OFF ch3	Click ON (turn ON) Click OFF (turn OFF)
4	ON/OFF ch4	Click ON (turn ON) Click OFF (turn OFF)

COMMANDS: 0-10V

Set DIP 9 and 10 following SETUP &amp; INSTALLATION at page 5 to use local input 0-10V

Ch.	Function	Value		
		0V	1V	10V
1	ON/OFF ch1	OFF 0	ON 1 .. 10	
2	ON/OFF ch2	OFF 0	ON 1 .. 10	
3	ON/OFF ch3	OFF 0	ON 1 .. 10	
4	ON/OFF ch4	OFF 0	ON 1 .. 10	

COMMANDS: 1-10V / Potenziometer

Set DIP 9 and 10 following SETUP &amp; INSTALLATION at page 5 to use local input 1-10V

Ch.	Function	Value		
		0V	1V	10V
1	ON/OFF ch1	OFF 0	ON 1 .. 10	
2	ON/OFF ch2	OFF 0	ON 1 .. 10	
3	ON/OFF ch3	OFF 0	ON 1 .. 10	
4	ON/OFF ch4	OFF 0	ON 1 .. 10	

### ➤ DALI BUS SETUP

In **DALI BUS** all the leds are controlled by an external DALI controller

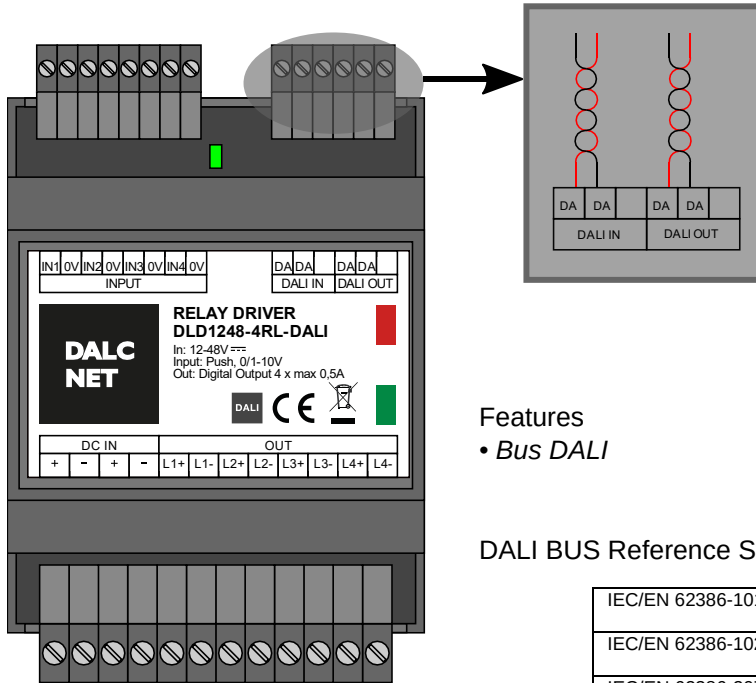

#### Features

- Bus DALI

#### DALI BUS Reference Standards

IEC/EN 62386-101	Digital addressable lighting interface – Part 101: General requirements - System
IEC/EN 62386-102	Digital addressable lighting interface – Part 102: General requirements – Control gear
IEC/EN 62386-207	Digital addressable lighting interface – Part 207: Particular requirements for control gear – LED modules (device type 6)

#### Onboard led:





- In the case of no bus power detected, or bus error, the led blinks fast (2 pulsed per second)
- In the case of bus power but no data, led blinks slow (1 pulse on second)
- In the case of data link active, the led stands on

#### Relation with local commands:

- At power-up, in case of absence of connection to the BUS, local control is active
- When the BUS is detected, the control passes to the BUS. It remains to the BUS until there is signal.
- In the absence of signal:
  - if the local command is N.O. PUSH BUTTON, the control passes to local command in the event of a N.O. push button pressure.
  - if the local command is 0-10V or 1-10V the control passes immediately to the local command.

#### Addressing

By selectors	✓
Simplified method (One ballast connected at a time)	✓
Random Address Allocation	✓

DALI	000 (default):			Address defined by DALI	
	from 001		to 064		First channel address, da 0 a 63
	FFF				(reserved)

**CHANNELS MAP – DALI**

Relay Driver outs (ON/OFF) are controlled by DALI MASTER controller

Addr	Function	Value	
+0	ON/OFF ch1	OFF 0	ON 1 .. 254
+1	ON/OFF ch2	OFF 0	ON 1 .. 254
+2	ON/OFF ch3	OFF 0	ON 1 .. 254
+3	ON/OFF ch4	OFF 0	ON 1 .. 254





## DALI COMMANDS

STANDARD COMMANDS	
DIRECT ARC POWER	✓
OFF	✓
UP	✓
DOWN	✓
STEP UP	✓
STEP DOWN	✓
RECALL MAX LEVEL	✓
RECALL MIN LEVEL	✓
STEP DOWN AND OFF	✓
ON AND STEP UP	✓
GO TO SCENE (0 to 15)	✓
RESET	✓
STORE ACTUAL LEVEL IN THE DTR	✓
STORE THE DTR AS MAX LEVEL	✓
STORE THE DTR AS MIN LEVEL	✓
STORE THE DTR AS SYSTEM FAILURE LEVEL	✓
STORE THE DTR AS POWER ON LEVEL	✓
STORE THE DTR AS FADE TIME	✓
STORE THE DTR AS FADE RATE	✓
STORE THE DTR AS SCENE (0 to 15)	✓
REMOVE FROM SCENE (0 to 15)	✓
ADD TO GROUP (0 to 15)	✓
REMOVE FROM GROUP (0 to 15)	✓
STORE DTR AS SHORT ADDRESS	✓
ENABLE WRITE MEMORY	✗
QUERY STATUS	6
QUERY BALLAST	✓
QUERY LAMP FAILURE	6
QUERY LAMP POWER ON	✓
QUERY LIMIT ERROR	✓
QUERY RESET STATE	✓
QUERY MISSING SHORT ADDRESS	✓
QUERY VERSION NUMBER	✓
QUERY CONTENT DTR	✓
QUERY DEVICE TYPE	7
QUERY PHYSICAL MINIMUM LEVEL	✓
QUERY POWER FAILURE	✓
QUERY CONTENT DTR1	✓
QUERY CONTENT DTR2	✓
QUERY ACTUAL LEVEL	✓
QUERY MAX LEVEL	✓
QUERY MIN LEVEL	✓
QUERY POWER OF LEVEL	✓
QUERY SYSTEM FAILURE LEVEL	✓
QUERY FADE TIME / FADE RATE	✓
QUERY SCENE LEVEL (0 to 15)	✓
QUERY GROUPS 0-7	✓
QUERY GROUPS 8-15	✓
QUERY RANDOM ADDRESS H	✓
QUERY RANDOM ADDRESS M	✓
QUERY RANDOM ADDRESS L	✓
READ MEMORY LOCATION	✗
QUERY EXTENDED VERSION	✗

SPECIAL COMMANDS	
TERMINATE	✓
DATA TRANSFER REGISTER	✓
INITIALIZE	✓
RANDOMIZE	✓
COMPARE	✓
WITHDRAW	✓
SEARCHADDR H	✓
SEARCHADDR M	✓
SARCHADDR L	✓
PROGRAM SHORT ADDRESS	✓
VERIFY SHORT ADDRESS	✓
QUERY SHORT ADDRESS	✓
PHSYCAL SELECTION	✗
ENABLE DEVIDE TYPE	✗
DATA TRANSFER REGISTER 1	✓
DATA TRASFER REGISTER 2	✓
WRITE MEMORY LOCATION	✗

<sup>6</sup> "Lamp failure" returns always "NO"

<sup>7</sup> "Query device type" returns DT6 but "Enable device Type" is not enabled



### ➤ DMX512-A/RDM BUS SETUP

With the **BUS DMX512+A/RDM** in the “slave” condition the outputs are managed by an external DMX controller. In the “master” condition, the DMX512+A/RDM become DMX controller and allows the communications between devices

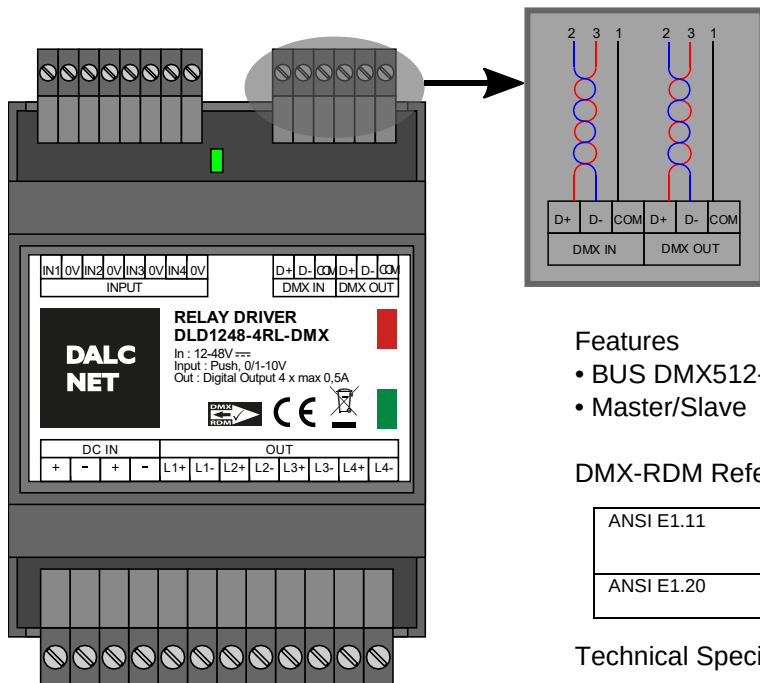

Use	3-Pin XLR Pin #	DMX512 Function
Command Reference	1	Data Link Common
Primary Data Link	2	Data 1-
	3	Data 1+
Secondary Data Link (Optional – see clause 4.8)	4	Data 2-
	5	Data 2+

### Features

- BUS DMX512-A (NSC+RDM)
- Master/Slave

### DMX-RDM Reference Standards

ANSI E1.11	Entertainment Technology – USITT DMX512-A – Asynchronous Serial Digital Data Transmission Standard for Controlling Lighting Equipment and Accessories
ANSI E1.20	Entertainment Technology – RDM – Remote Device Management over USITT DMX512 Networks

### Technical Specifications

Standard DMX512-4/RDM

### Onboard led:

- In the case of bus error, the led blinks fast (2 pulsed per second)
- In the case of no bus detected, led blinks slow (1 pulse per second)
- In the case of data link active, the led stands on.

### Relation with local commands:

- At power-up, in case of absence of connection to the BUS, local control is active
- When the BUS is detected, the control passes to the BUS. It remains to the BUS until there is signal.
- In the absence of signal:
  - if the local command is N.O. PUSH BUTTON, the control passes to local command in the event of a N.O. push button pressure.
  - if the local command is 0-10V or 1-10V the control passes immediately to the local command.

### Addressing

RDM	✓
By selectors	✓

DMX	000 (default):		Address defined by RDM	
	from 001		to	First channel address, from 1 to 512
	F00		MASTER	

Note: addressing must be set by selectors

**CHANNEL MAP – DMX512-A/RDM**

Relay Driver outs (ON/OFF) are managed by DMX Master controller

Ch.	Function	Value	
+0	ON/OFF ch1	OFF 0	ON 1 .. 255
+1	ON/OFF ch2	OFF 0	ON 1 .. 255
+2	ON/OFF ch3	OFF 0	ON 1 .. 255
+3	ON/OFF ch4	OFF 0	ON 1 .. 255

**RDM COMMANDS**

<i>REQUIRED PARAMETER</i>	
DISC_UNIQUE_BRANCH	✓
DISC_MUTE	✓
DISC_UN_MUTE	✓
SUPPORTED_PARAMETERS	✓
PARAMETERS_DESCRIPTION	✓
DEVICE_INFO	✓
SOFTWARE_VERSION_LABEL	✓
DMX_START_ADDRESS	✓
IDENTIFY_DEVICE	✓

<i>SUPPORTED PARAMETER</i>	
PRODUCT_DETAIL_ID_LIST	✓
DEVICE_MODEL_DESCRIPTION	✓
MANUFACTERER_LABEL	✓
DEVICE_LABEL	✓
BOOT_SOFTWARE_VERSION_ID	✓
BOOT_SOFTWARE_VERSION_LABEL	✓
DMX_PERSONALITY	✓
DMX_PERSONALITY_DESCRIPTION	✓
SLOT_INFO	✓
SLOT_DESCRIPTION	✓
DEFAULT_SLOT_VALUE	✓



## ➤ DMX MASTER / SLAVE

**MASTER:**

Note: Master and Slave must have setted the same map

Default Master:

**SLAVE:**

Note: Master and Slave must have setted the same map

Default Slave:

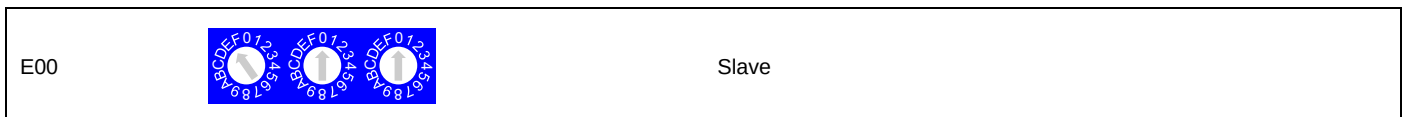

### ➤ MODBUS SETUP

In **MODBUS SETUP** in the “slave” condition the outputs LEDs are managed by an external MODBUS RTU master controller (RS-458)

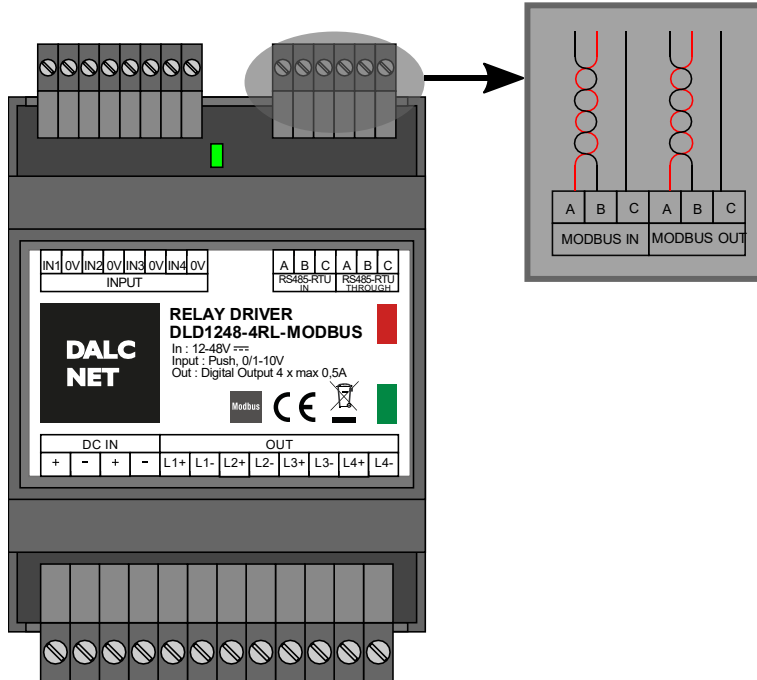

**Features**

- BUS MODBUS RTU SLAVE su RS485

**BUS MODBUS Reference Standards**

- MODBUS APPLICATION PROTOCOL SPECIFICATION V1.1b



Onboard led:

- In the case of bus error, the led blinks fast (2 pulsed per second)
- In the case of no bus detected, led blinks slow (1 pulse per second)
- In the case of data link active, the led stands on.





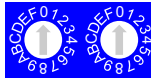
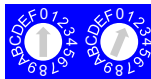



Relation with local commands:

- At power-up, in case of absence of connection to the BUS, local control is active
- When the BUS is detected, the control passes to the BUS. It remains to the BUS until there is signal.
- In the absence of signal:
  - if the local command is N.O. PUSH BUTTON, the control passes to local command in the event of a N.O. push button pressure.
  - if the local command is 0-10V or 1-10V the control passes immediately to the local command.

Addressin by selectors

Selectors x10, x1 (middle and right)			
Modbus	00 (default):		Default modbus ID (1)
	from 01		to 99 
Modbus ID			

Selectors x100 (left)								
Modbus								
	0 115200 baud 8N1	1 115200 baud 8E1	2 38400 baud 8N1	3 38400 baud 8E1	4 19200 baud 8N1	5 19200 baud 8E1	6 9600 baud 8N1	7 9600 baud 8E1



## CHANNELS MAP – MODBUS

Var	Function	Value
+0	ON/OFF ch1	OFF 0 ON 1 .. 255
+1	ON/OFF ch2	OFF 0 ON 1 .. 255
+2	ON/OFF ch3	OFF 0 ON 1 .. 255
+3	ON/OFF ch4	OFF 0 ON 1 .. 255

## SUPPORTED FUNCTIONS FOR READING AND WRITING – MODBUS RTU

Function code		
0x01	Read Coils	✘
0x02	Read Discrete Inputs	✘
0x03	Read Holding Registers	✔
0x04	Read Input Register	✘
0x05	Write Single Coil	✘
0x06	Write Single Register	✔
0x07	Read Exception Status	✘
0x08	Diagnostic	✘
0x0B	Get Com Event Counter	✘
0x0C	Get Com Event Long	✘
0x0F	Write Multiple Coils	✘
0x10	Write Multiple Registers	✔
0x11	Report Server ID	✘
0x14	Read File Record	✘
0x15	Write File Record	✘
0x16	Mask Write Register	✘
0x17	Read/Write Multiple Registers	✘
0x18	Read FIFO queue	✘
0x2B	Read Device Identification	✘