



DALCNET S.r.l.
 Registered office:
 via dei Laghi, 31 - 36077 Altavilla Vicentina (VI) - Italy
 Headquarters : via A.Meucci, 35 - 36040 Brendola (VI) - Italy
 VAT: IT04023100235 - Tel. +39 0444 1836680
 www.dalcnet.com - info@dalcnet.com

Casambi Dimmer

D118x18-1224-4CV-CASAMBI

PRELIMINARY



Made in Italy

Rev. 04/03/2019
 pag. 1/5

Device Manual



FEATURES

- DIMMER+CASAMBI
- DC Input: 12-24 Vdc
- Command: APP CASAMBI
- N°4 Output channels
- Control: Dimmer White, Tunable White, RGB e RGBW
- Constant Voltage variant for Common Anode applications
- Voltage outputs for R loads
- Memory function
- Adjusting the brightness of white light, monochromatic color, Tunable White
- Creating multiple colour scenes and selecting colour games
- Adjusting the brightness up to completed off
- Soft start and soft stop
- Typical efficiency > 95%
- 100% Functional test

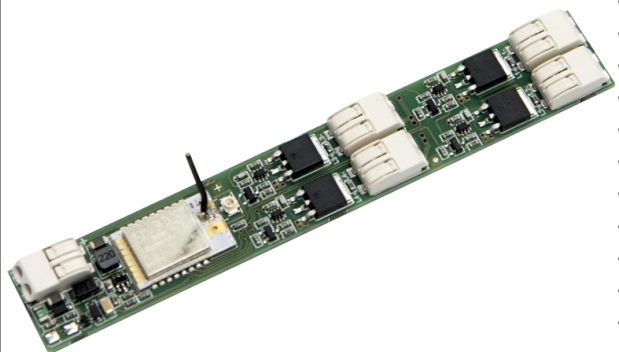

➤ CONSTANT VOLTAGE VARIANTS

CODE	Input voltage	Channels	Output	Command	
D118x18-1224-4CV-CBU	12-24V DC	4	4 x 4A (max 6A tot.)	APP CASAMBI	

As default, D80x18-1224-2CV-CBU is delivered with RGB+W configuration

➤ PROTECTIONS

OVP	Over voltage protection (*)		✓
RVP	Reverse polarity protection (*)		✓
IFP	Input fuse protection (*)		✓

(*) Only control Logic protection

➤ TYPE OF PROFILE

PROFILE	Supply Voltage	Output	Channels	Commands	
WHITE	12-24V DC	2 x CV	4	APP CASAMBI	DIMMER
TUNABLE WHITE	12-24V DC	2 x CV	2	APP CASAMBI	TUNABLE WHITE
RGB	12-24V DC	3 x CV	3	APP CASAMBI	RGB
RGB+W	12-24V DC	4 x CV	3+1	APP CASAMBI	RGB W

LED DIMMER

➤ **REFERENCE STANDARDS**

EN 61347-1	Lamp controlgear - Part 1: General and safety requirements
EN 55015	Limits and methods of measurement of radio disturbance characteristics of electrical lighting and similar equipment
EN 61547	Equipment for general lighting purposes - EMC immunity requirements

➤ **TECHNICAL SPECIFICATIONS**

		Constant voltage	
Supply voltage		min: 10,8 Vdc .. max: 26,4 Vdc	
Input current		Max 6A	
Channels		4	
Output voltage		= Vin	
Output current		A/ch	A tot
		4A ¹⁾	6A ¹⁾
Absorbed nominal power ¹⁾	@12V	48 W	72 W
	@24V	96 W	144 W
Power loss in stand by mode		<500mW	
Type of Load		R	
D-PWM dimming frequency		600 Hz	
D-PWM resolution		833 step	
Operating frequencies		2,400 ... 2,483 GHz	
Maximum output power		4dBm	
D-PWM range		0 – 100%	
Storage Temperature		min: -40 max: +60 °C	
Ambient Temperature ¹⁾		min: -10 max: +40 °C	
Wiring		0,2 ... 0,75mm ² – 24 ... 18 AWG Solid Sizes 0,2 ... 0,75mm ² – 24 ... 18 AWG Stranded Sizes	
Wire preparation length		7 ÷ 10mm	
Mechanical dimensions		118 x 18 x 6 mm	
Fixing		Biadhesive	
Weight		13 g	

¹⁾ Maximum value, dependent on the dissipation conditions. This value is measured at 40°C, it is maximum ambient temperature.

➤ **MECHANICAL DIMENSION**

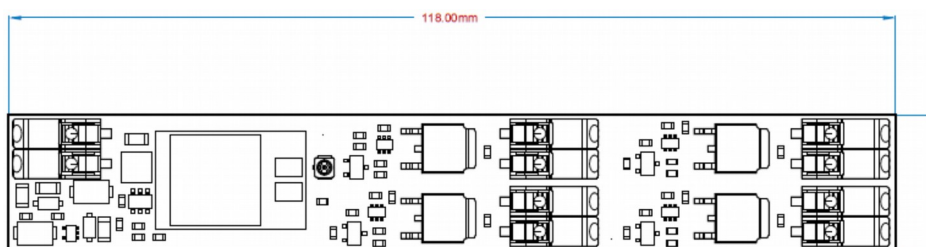



DALCNET S.r.l.
 Registered office:
 via dei Laghi, 31 - 36077 Altavilla Vicentina (VI) - Italy
 Headquarters : via A.Meucci, 35 - 36040 Brendola (VI) - Italy
 VAT: IT04023100235 - Tel. +39 0444 1836680
 www.dalcnet.com - info@dalcnet.com

Casambi Dimmer
 D118x18-1224-4CV-CASAMBI
PRELIMINARY
 Device Manual



Made in Italy
 Rev. 04/03/2019
 pag. 3/5

➤ **INSTALLATION**

To set the product, follow the instruction on the picture below:

- 1) Fix the Casambi Dimmer to the aluminium profile by the provided thermal biadhesive
- 2) connect the LED in the output of the dimmer
- 3) connect the power supply in the input of the dimmer

DIMMER CASAMBI as any other Casambi product, should not be placed in a metal enclosure or next to large metal structures. Metal will effectively block all radio signals which are crucial to the operation of the product.

■ **Wiring diagram: 1-2-3-4 separate channels**

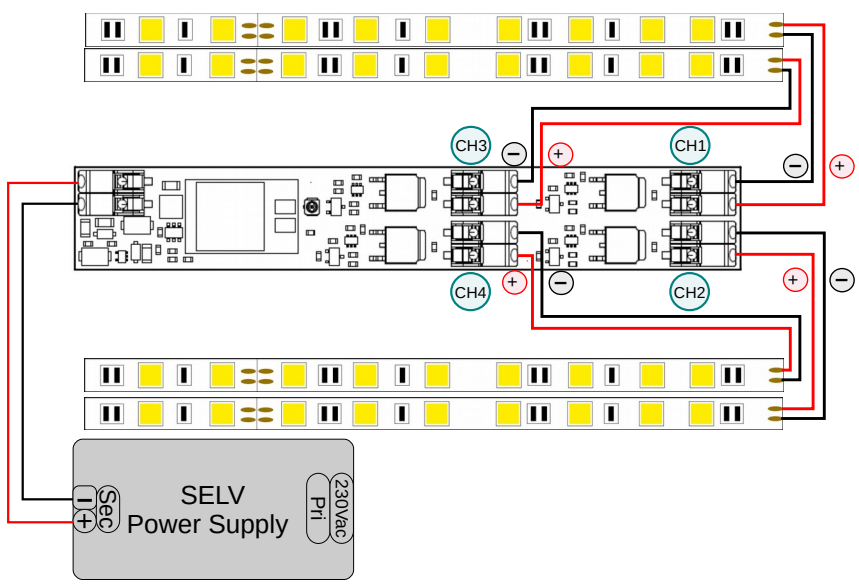

Channel 1: Dimmer 

Channel 2: Dimmer 

Channel 3: Dimmer 

Channel 4: Dimmer 

Dimmer	100.0 %	
Dimmer	100.0 %	
Dimmer	100.0 %	
Dimmer	100.0 %	

■ **Wiring diagram: Tunable White**

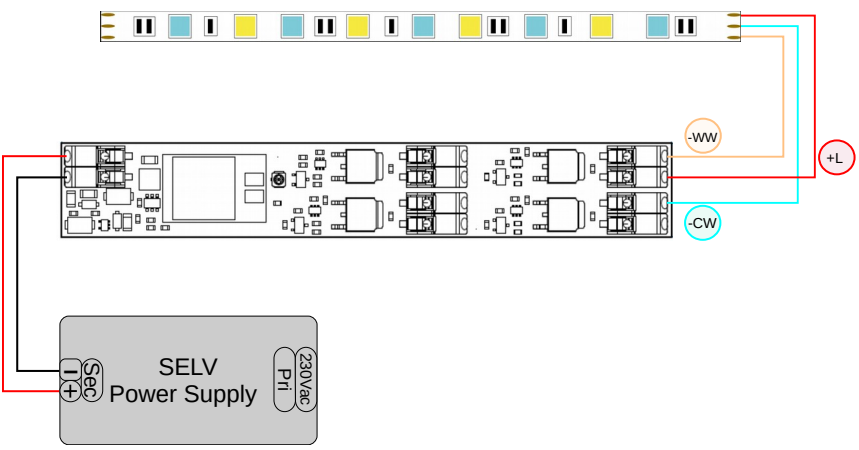

Channel 1: Dimmer 

Channel 2: Colour Temperature 

Dimmer	100.0 %	
Temperatura colore	4700 K	

■ **Wiring diagram: RGB**

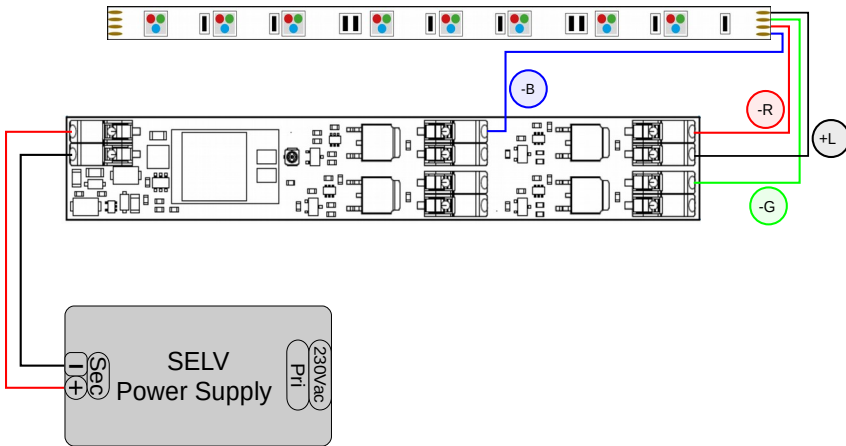

Channel 1: Dimmer



Channel 2: Colour



Channel 3: Colour saturation

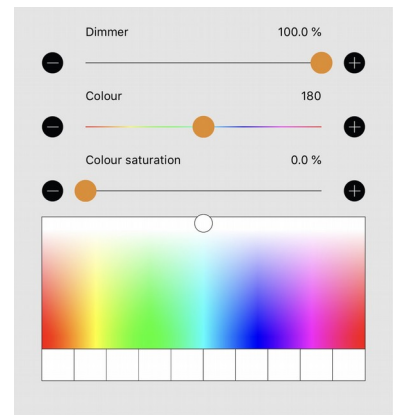

■ **Wiring diagram: RGB+W**

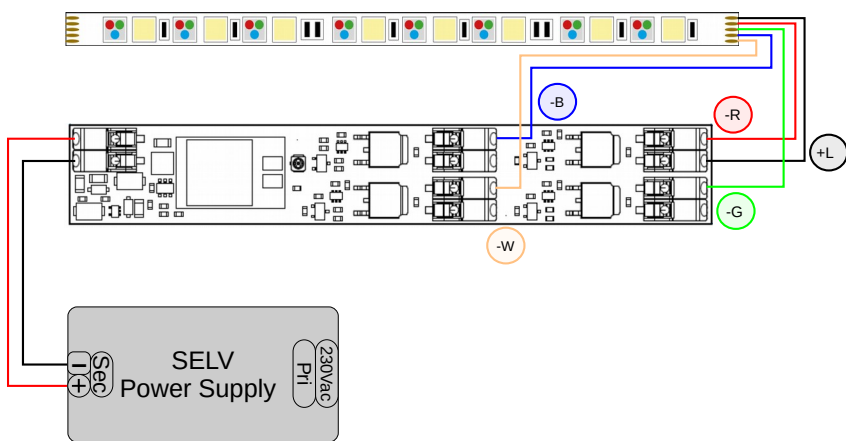

Channel 1: Dimmer



Channel 2: White / Colour



Channel 3: Temperature color

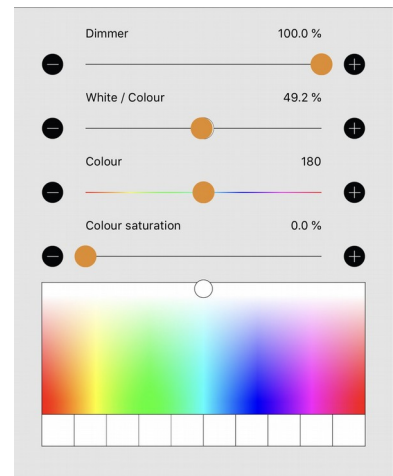

Channel 4: Colour saturation



TECHNICAL NOTE

Installation:

- Installation and maintenance must be performed only by qualified personnel in compliance with current regulations.
- The product must be dissipated correctly.
- Keep separated the circuits at 230V (LV) and the circuits not SELV from circuits to low voltage (SELV) and from any connection with this product. It is absolutely forbidden to connect, for any reason whatsoever, directly or indirectly, the 230V mains voltage to the bus or to other parts of the circuit.

Power Supply:

- For the power supply use only a SELV power supplies with limited current, short circuit protection and the power must be dimensioned correctly. In case of using power supply with ground terminals, all points of the protective earth (PE = Protection Earth) must be connected to a valid and certified protection earth.
- The connection cables between the power source "low voltage" and the product must be dimensioned correctly and they should be isolated from every wiring or parts at voltage not SELV. It is suggested to use double insulated shielded.
- Dimension the power supply for the load connected to the device. If the power supply is oversized compared with the maximum absorbed current, insert a protection against over-current between the power supply and the device.

Outputs:

- The length of the connection cables between the product and the LED module must be less than 10m; the cables must be dimensioned correctly and they should be isolated from every wiring or parts at voltage not SELV. It is suggested to use double insulated shielded and twisted cables.